

Rotational Position Transducer

0...5, 0...10 VDC Output
Ranges: 0-90° to 0-50 Turns
Industrial Grade



RT9510



Specification Summary:

GENERAL

Full Stroke Range Options 0-0.125 to 0-50 turns
 Output Signal Options 0...5, 0...10 VDC
 Accuracy $\pm 0.30\%$ to $\pm 0.15\%$ full stroke *see ordering information*
 Repeatability $\pm 0.05\%$ full stroke
 Resolution essentially infinite
 Enclosure Material powder-painted aluminum or stainless steel
 Sensor plastic-hybrid precision potentiometer
 Potentiometer Cycle Life *see ordering information*
 Shaft Loading up to 35 lbs. radial and 5 lbs. axial
 Weight, Aluminum (Stainless Steel) Enclosure 5 lbs. (10 lbs.) max.

ELECTRICAL

Input 14.5-40 VDC (10.5-40 VDC for 0...5 volt output)
 Input Current 10 mA maximum
 Output Impedance 1000 ohms
 Maximum Load 5000 ohms
 Zero Adjustment from factory set zero to 50% of full stroke range
 Span Adjustment to 50% of factory set span

ENVIRONMENTAL

Enclosure NEMA 4/4X/6, IP 67/68
 Operating Temperature -40° to 200°F (-40° to 90°C)
 Vibration up to 10 G's to 2000 Hz maximum

EMC COMPLIANCE PER DIRECTIVE 89/336/EEC

Emission/Immunity EN50081-2 / EN50082-2

The RT9510 is an incredibly simple device which provides a regulated 0...10VDC rotational-position feedback signal with a 14.5...40 VDC unregulated input voltage.

This innovative sensor from Celesco, designed to meet tough NEMA-4 and IP67 environmental standards, is available in full-stroke measurement ranges of 1/4 to 50 turns. Because the sensor is potentiometric, the RT9510 is absolute and will maintain position information even after a loss of power.

Outline Drawing

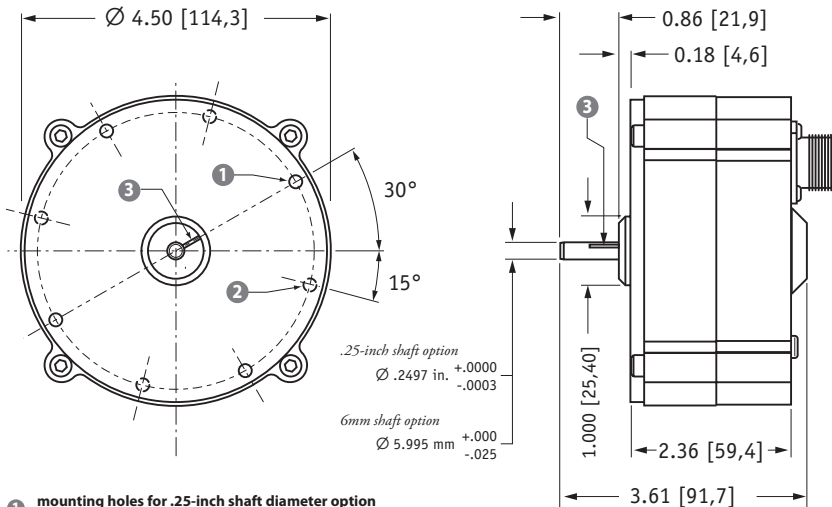

- 1 mounting holes for .25-inch shaft diameter option
#8-32 x 0.180 @ 90° apart on a 4.15 in. dia. BC (4 places)
- 2 mounting holes for 6-mm shaft diameter option
M4 x 4,5 mm @ 90° apart on a 105,4 mm dia. BC (4 places)
- 3 reference mark
full counter-clockwise position - align mark on shaft to mark on face for start of measurement range

ALL DIMENSIONS ARE IN INCHES [MM]

Output Signal

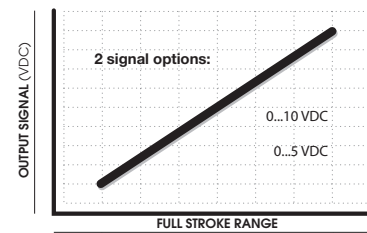

Ordering Information:

Model Number:

RT9510- _____ **-** _____ **-** _____ **1** **-** _____ **1** _____ **0** _____
order code: R A B C D E F G

Sample Model Number:

RT9510 - 0005 - 111 - 1110

- R** range: 5 turns (clockwise shaft rotations)
- A** enclosure: aluminum
- B** shaft diameter: .25 inches
- C** output signal: 0...10 VDC signal increasing clockwise
- F** electrical connection: 6-pin plastic connector

Full Stroke Range:





R order code:	R125	0R25	0R50	0001	0002	0003	0005	0010	0020	0030	0050
clockwise shaft rotations, min:	0.125	0.25	0.50	1	2	3	5	10	20	30	50
accuracy (% of f.s.):	0.3%	0.3%	0.3%	0.3%	0.3%	0.3%	0.2%	0.15%	0.15%	0.15%	0.15%
potentiometer cycle life*:	2.5×10^6	2.5×10^6	2.5×10^6	2.5×10^6	2.5×10^6	2.5×10^6	5×10^5	2.5×10^5	2.5×10^5	2.5×10^5	2.5×10^5

*—number of times the sensor shaft can be cycled back and forth from beginning to end and back to the beginning before any measurable signal degradation may occur.

Enclosure Material:

A order code:	1	2
	powder-painted aluminum	303 stainless steel

Shaft Diameter:

B order code:	1	2	3	4
	0.25-in. diameter	6 mm diameter	0.25-in. dia. w/flats	6 mm dia. w/flats
				
	.2497 in. (+.0000 - .0003)	5.995 mm (+.000 - .025)	0.33 in. 0.025 in.	8.4 mm 0.64 mm

Output Signals:

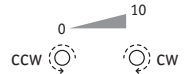
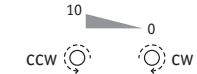
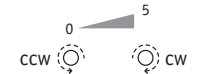
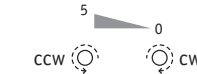

F order code:	1	2	3	4
output signal options:	0...10 VDC	10...0 VDC	0...5 VDC	5...0 VDC
				
input voltage:	14.5...40 VDC		10.5...40 VDC	

Example:

ordercode = **1** = 0...10 VDC { max ccw = 0 VDC max cw = 10 VDC

Ordering Information:

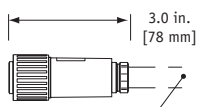
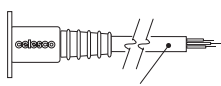
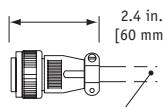
Electrical Connection:

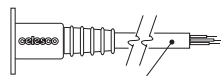
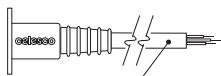
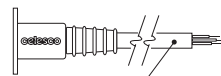
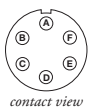
<p>1</p> <p>order code:</p> <p>6-pin plastic connector w/mating plug IP 67, NEMA 4X**, 6</p>  <p>3.0 in. [78 mm]</p> <p>1/2 - 5/16" [14 - 8 mm] cable dia. 16 AWG max conductor size connector: MS3102E-14S-6P mating plug: MS3106E-14S-6S</p>	<p>2</p> <p>10-ft. [3 M] waterproof cable IP 67, NEMA 4X**, 6</p>  <p>10 ft. x 0.4-in. dia. [3 M x 10 mm dia.] 18 AWG, type SJTW</p>	<p>3</p> <p>6-pin metal connector w/mating plug IP 65, NEMA 4</p>  <p>2.4 in. [60 mm]</p> <p>3/8-in. [9 mm] max cable dia. 16 AWG max conductor size connector: MS3102E-14S-6P mating plug: MS3106E-14S-6S</p>	<p>4</p> <p>25-ft. [7.5 M] instrumentation cable IP 67, NEMA 6</p>  <p>25 ft. x 0.2-in. dia. [7,5 M x 5 mm dia.] 24 AWG, shielded</p>																								
<p>5</p> <p>order code:</p> <p>100-ft. [30 M] waterproof cable IP 67, NEMA 4X**, 6</p>  <p>100 ft. x 0.4-in. dia. [30 M x 10 mm dia.] 18 AWG, type SJTW</p>	<p>6</p> <p>10-ft. [3 M] pressure tested* waterproof cable IP 68, NEMA 4X**, 6P</p>  <p>10 ft. x 0.4-in. dia. [3 M x 10 mm dia.] 18 AWG, type SJTW</p>	<p>7</p> <p>100-ft. [30 M] pressure tested* waterproof cable IP 68, NEMA 4X**, 6P</p>  <p>100 ft. x 0.4-in. dia. [30 M x 10 mm dia.] 18 AWG, type SJTW</p>																									
<p>6-pin Mating Plug</p> <table border="0"> <tr> <td>pin</td> <td>signal</td> </tr> <tr> <td>A</td> <td>input voltage</td> </tr> <tr> <td>B</td> <td>output signal</td> </tr> <tr> <td>C</td> <td>common</td> </tr> </table>  <p>contact view</p>	pin	signal	A	input voltage	B	output signal	C	common	<p>Waterproof Cable</p> <table border="0"> <tr> <td>color code</td> <td>signal</td> </tr> <tr> <td>WHITE</td> <td>input voltage</td> </tr> <tr> <td>GREEN</td> <td>output signal</td> </tr> <tr> <td>BLACK</td> <td>common</td> </tr> </table>	color code	signal	WHITE	input voltage	GREEN	output signal	BLACK	common	<p>Instrumentation Cable</p> <table border="0"> <tr> <td>color code</td> <td>signal</td> </tr> <tr> <td>RED</td> <td>input voltage</td> </tr> <tr> <td>GREEN</td> <td>output signal</td> </tr> <tr> <td>BLACK</td> <td>common</td> </tr> </table>	color code	signal	RED	input voltage	GREEN	output signal	BLACK	common	
pin	signal																										
A	input voltage																										
B	output signal																										
C	common																										
color code	signal																										
WHITE	input voltage																										
GREEN	output signal																										
BLACK	common																										
color code	signal																										
RED	input voltage																										
GREEN	output signal																										
BLACK	common																										

*-Test pressure: 100 feet [30 meters] H₂O (40 PSID); Test Medium: Air; Duration: 2 hours. **-Applies to stainless steel enclosure only.

Output Signal Selection:

The output signal direction can be reversed at any time by simply changing the dip-switch settings found on the internal signal board. After the settings have been changed, adjustment of the Zero and Span trimpots will be required to precisely match signal values to the beginning and end points of the stroke.

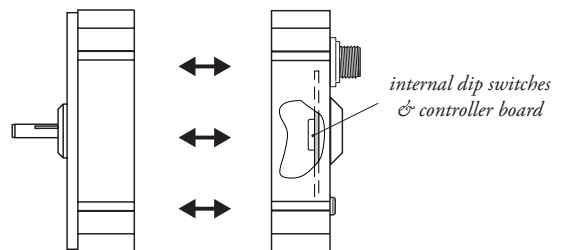
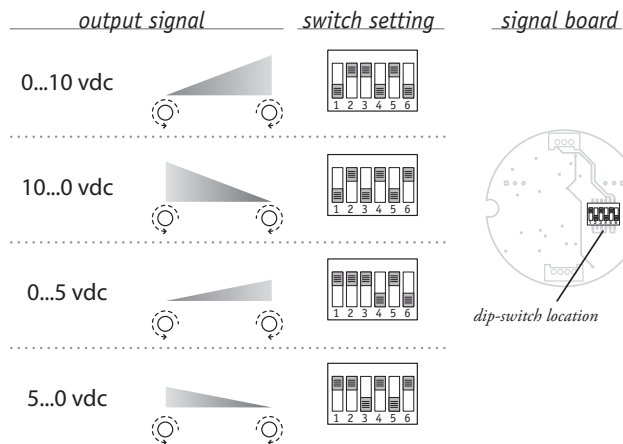

To gain access to the signal board, remove four Allen-Head Screws and separate the two case halves.

version: 3.0 last updated: July 14, 2008

RT9510 | 240