

Digital Output Module 4-Channel Version for Zone 1

Series 9475/32-04-72



www.stahl.de



15278E00

- > 4-channel digital output
- > Intrinsically safe outputs Ex ib
- > For Ex i hydraulic valves and solenoid valves
- > Additional Ex i control input for "Plant STOP" (acc. IEC61508 up to SIL2)
- > Line fault monitoring and LED display per channel
- > LED display for output signal per channel
- > Diagnostics based on NE107
- > Module can be replaced in the hazardous area under power (hot swap)



A4

The Digital Output Module is used for connecting of up to 4 intrinsically safe hydraulic or solenoid valves to the IS1 remote I/O system. The additional Ex i control input "Plant STOP" is used for safe switching off of all outputs. All channels are individually monitored for wire breakage and short-circuit. The Ex i outputs are short-circuit proof, galvanically connected to each and galvanically separated from the system.



	ATEX / IECEx						NEC 505						NEC 506						NEC 500					
	0	1	2	20	21	22	Zone	0	1	2	20	21	22	Division	1	2	1	2	1	2				
Ex interface		x	x		x	x	Ex interface		x	x		x	x	Ex interface	x	x	x	x	x	x				
Installation in		x	x		x	x	Installation in		x	x		x	x	Installation in	x	x	x	x	x	x				

WebCode 9475F

Digital Output Module 4-Channel Version for Zone 1

Series 9475/32-04-72



Explosion Protection

Global (IECEX)

Gas and dust	IECEX DEK 12.0070X Ex ia [ib Gb] IIC T4 Gb [Ex ib Db] IIIC
--------------	--

Europe (ATEX)

Gas and dust	DEKRA 12 ATEX0232X Ⓢ II 2 (2) G Ex ia [ib Gb] IIC T4 Gb Ⓢ II (2) D [Ex ib Db] IIIC
--------------	--

Certifications and certificates

Certificates	ATEX, IECEX, Brazil (INMETRO), Canada (cFM), Russia (GOST R), USA (FM), Belarus (operating authorisation)
Ship approval	ABS, BV, ClassNK, DNVGL, LR, RS

Further parameters

Installation	in Zone 1, Zone 2, Zone 21, Zone 22 and in the safe area
Further information	see respective certificate and operating instructions

Safety data

Max. voltage U_o	15.4 V						
Output ib							
Max. current I_o	115.4 mA						
Max. power P_o	1475 mW						
Max. connectable inductance L_o / capacity C_o							
IIC	L_o [mH]	0.11	0.1	0.05	0.02	0.01	
	C_o [nF]	257	267	337	477	488	
IIC at ≤ 700 m line ($\leq 1 \mu\text{H/m}$; $\leq 200 \text{ pF/m}$; $\geq 10.76 \text{ m}\Omega/\text{m}$)	L_o [mH]	0.05					
	C_o [nF]	217					
IIB / IIIC	L_o [mH]	2.9	2.0	1.0	0.5	0.05	0.02
	C_o [nF]	1467	1767	2367	2667	2767	3157
IIB / IIIC at ≤ 2000 m line ($\leq 1 \mu\text{H/m}$; $\leq 200 \text{ pF/m}$; $\geq 10.76 \text{ m}\Omega/\text{m}$)	L_o [mH]	2.0	1.0	0.5	0.02		
	C_o [nF]	1667	2367	2667	3967		
Max. internal capacity C_i	33 nF (in the above tables, C_i is subtracted from C_o)						
Max. internal inductance L_i	negligible						
Ex i control input "Pant STOP"							
Connection terminals				X3 1, 2 (without galvanic separation, 9475/22 compatible)			X3 3, 4 (with galvanic separation, switchable in parallel)
Type of protection				Ex ia			Ex ia
Max. voltage U_o				5.1 V			--
Max. current I_o				0.44 mA			--
Max. power P_o				0.5 mW			--
Max. connectable inductance L_o /capacity C_o							
IIC	L_o [mH]	100	10	2	1	0.2	0.01
	C_o [μF]	2.195	2.595	3.295	3.695	5.495	15.995
IIB / IIIC	L_o [mH]	100	10	2	1	0.2	0.01
	C_o [μF]	9.995	12.995	16.995	19.995	31.995	159.995
Max. voltage U_i				--			30 V
Max. internal resistance R_i				--			4940 Ω
Max. internal capacity C_i				5.2 nF (in the above tables, C_i is subtracted from C_o)			negligible
Max. internal inductance L_i				negligible			negligible

Digital Output Module 4-Channel Version for Zone 1

Series 9475/32-04-72



Selection Table

Version	Open-circuit voltage	Max. output current	Internal resistance	Installation	Order number	Weight
Digital Output Module with "Plant STOP"	13.8 V	95 / 75 mA	23.2 Ω	Zone 1	9475/32-04-72	kg 0.275

Note Please order terminal separately - see Accessories

Technical Data

Electrical data

Design

Ex i outputs

Number of channels	3
Open-circuit voltage	13.8 V
Output nominal current	95 mA
Internal resistance	23.2 Ω
Rated operation	
U	11.7 V
I	95 mA

Output characteristic

3 channels with 9475/32-04-72

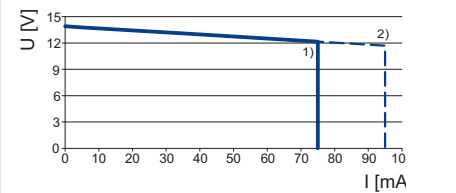

1) 4 channels 2) max. 3 channels
Notice: In case of operation with 4 outputs and a total current > 320 mA, output 4 will be pulsed. Reduce the load current to < 320 mA!

4 channels with 9475/32-04-72

Number of channels	4
Open-circuit voltage	13.8 V
Output nominal current	75 mA
Internal resistance	23.2 Ω
Rated operation	
U	12.3 V
I	75 mA

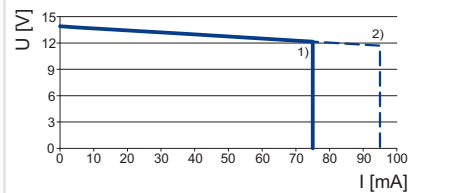

1) 4 channels 2) max. 3 channels
Notice: In case of operation with 4 outputs and a total current > 320 mA, output 4 will be pulsed. Reduce the load current to < 320 mA!

Ex i control input X3

Function	"Plant STOP" to switch off all outputs
Suitability	Switch-off up to SIL 2 (IEC61508)
Connection terminals	

	X3 1, 2 (without galvanic separation, 9475/22 compatible)	X3 3, 4 (with galvanic separation, switchable in parallel)
Supply voltage	3.3 V	--
Internal resistance	20.5 kΩ	--
Control voltage for all outputs		
„OFF“ („Plant STOP“ activated)	> 2.2 V	< 1 V
„Normal operation“ („Plant STOP“ deactivated)	< 0.7 V	> 6 V

Galvanic separation

Test voltage	
acc. to standard	EN 60079-11
Between auxiliary power/system components	≥ 1500 V AC
Between two I/O modules	≥ 500 V AC
Between I/O channels/system components	≥ 500 V AC
Between I/O channels/ground (PA)	≥ 500 V AC
Between I/O channels/"Plant STOP" (X3 3, 4)	≥ 500 V AC
Between "Plant STOP" (X3 3, 4)/earth (PA)	≥ 500 V AC

Electromagnetic compatibility

Tested to the following standards and regulations:
 EN 61326-1 (2006) IEC 61000-4-1 ... 6, NAMUR NE 21

Digital Output Module 4-Channel Version for Zone 1

Series 9475/32-04-72



Electrical connection	
Power supply	BusRail Types 9494
Ex i field signals	Pluggable, blue terminals, 16-pole, 2.5 mm ² , screw- or spring-type versions with lock
Ex i control input	Pluggable, blue terminal, 2-pole, 2.5 mm ² , screw type version with lock
Auxiliary power	
Version	Intrinsically safe Ex ia via BusRail
Behaviour during undervoltage	all outputs "OFF"
Max. current consumption	250 mA
Max. power consumption	6 W
Max. power dissipation	5.8 W
Max. power dissipation in rated operation	3.4 W
Device-specific data	
Settings	
Module	
Diagnosis messages	ON / OFF
Signal	
Line fault monitoring	ON / ON without test current / OFF
Behaviour in case of error	ON / OFF / hold last value
Ambient conditions	
Ambient temperature	-40 ... +75 °C (observe operating instructions)
Storage temperature	-40 ... +80 °C
Maximum relative humidity	95 % (without condensation)
Semi-sinusoidal shock (IEC EN 60068-2-27)	15 g (3 shocks per axis and direction)
Sinusoidal vibration (IEC EN 60068-2-6)	1 g in the frequency range 10 ... 500 Hz 2 g in the frequency range 45 ... 100 Hz
Mechanical data	
Degree of protection (IEC 60529)	IP20
Module enclosure	polyamide 6GF
Fire resistance (UL 94)	V2
Pollutant class	corresponds to G3
Dimensions	L = 128 mm, W = 96.5 mm, H = 67 mm
Indication	
LED indication	
Module requires maintenance	LED "M/S", blue
Operating state	LED "RUN", green
Group error	LED "ERR", red
Channel error	LED red, for each channel
Channel status	LED yellow, for each channel
"Plant STOP"	LED yellow ("Plant STOP" active, all outputs are high-impedance)
Function indication	
Retrievable parameters	Manufacturer, Type, hardware revision, software revision, serial number
Error indication	
Module status and alarms	<ul style="list-style-type: none"> • Internal bus error primer / redundant • No response from IOM • Configuration does not correspond to module • Hardware error • Excess temperature • Slot error • Module requires maintenance
Signal errors for each channel	
Signal status bit	"0" = output high-impedance / "1" = output is supplied
Wire breakage output	> 1 k Ω (response range 1 ... 5 k Ω) (with deactivated test current can be detected only if the output is switched on)
Short circuit output	< 30 Ω (response range 30 ... 60 Ω) (can be detected only if the output is switched on)

Digital Output Module 4-Channel Version for Zone 1

Series 9475/32-04-72



Mounting / Installation

Mounting orientation horizontal or vertical (observe operating instructions)
 Mounting type on 35 mm DIN rail LV 35/15 (DIN EN 60715)



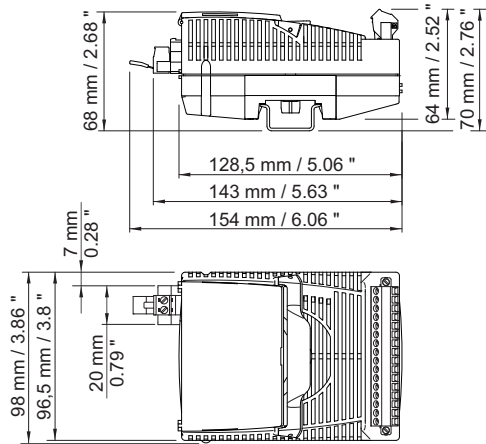



Dimensional drawings (all dimensions in mm / inches) - subject to modifications



10989E00

A4

Accessories and Spare Parts



Designation	Figure	Description	Art. no.
Pluggable terminal	 02079E00	2.5 mm ² with lock, 16-pole, screw connector, blue, for connecting the field signals to I/O modules, for intrinsically safe field circuits Labelling: 1 ... 16 Attention: An additional terminal is necessary for I/O module Series 9470 and 9480. Designation: 17 ... 32	162702
	 02077E00	2.5 mm ² with lock, 16-pole, spring clamp connection, blue, for connecting the field signals to I/O modules, for intrinsically safe field circuits, incl. test jacks Labelling: 1 ... 16 Attention: An additional terminal is necessary for I/O module Series 9470 and 9480. Designation: 17 ... 32	162695
mA - Isolating Repeater	 10389E00	The mA isolating repeaters are used for the connection of 4-wire transmitters to active 2-wire inputs and for the galvanic separation. Input: sink, Ex e Output: sink, Ex i	160166
	 04653E00	The mA isolating repeaters are used for the connection of 4-wire transmitters to active 2-wire inputs and for the galvanic separation. Input: sink, Ex i Output: sink, Ex i	160165
Labelling strips	 05869E00	"FB Addr ... Mod No ..." for pluggable terminal, sheet with 26 strips	162788
DIN A4 sheet	 09900E00	For label plate on I/O modules; 6 labels on each sheet; print-out using IS Wizard; packaging unit = 20 sheets	162832

Digital Output Module 4-Channel Version for Zone 1

Series 9475/32-04-72



Accessories and Spare Parts

Designation	Figure	Description	Art. no.
Partition	 <p>15196E00</p>	For mounting between intrinsically safe and non-intrinsically safe connections of the I/O modules, in order to adhere to the required 50 mm distance	220101
Warning sign	 <p>05872E00</p>	"Clean modules only with a damp cloth."	162796

We reserve the right to make alterations to the technical data, dimensions, weights, designs and products available without notice. The illustrations cannot be considered binding.