

Digital Output Module 8-Channel Version for Zone 1

Series 9475/32-08-.2



www.stahl.de



15237E00

- > 8-channel digital output
- > Intrinsically safe outputs Ex ia
- > For Ex i solenoid valves and display elements
- > Additional Ex i control input for "Plant STOP" (acc. IEC61508 up to SIL2)
- > Line fault monitoring and LED display per channel
- > LED display for output signal per channel
- > Diagnostics based on NE107
- > Module can be replaced in the hazardous area under power (hot swap)



A4

The Digital Output Module is used for connecting of up to 8 intrinsically safe solenoid valves, indication or signal elements to the IS1 remote I/O system. All channels are individually monitored for wire breakage and short-circuit. The Ex i outputs are short-circuit proof, galvanically connected to each and galvanically separated from the system.



Compatible spare for IS1 I/O modules: Series 9475/12-08-51, 9475/12-08-61, 9475/22-08-51 (without Plant STOP), 9475/22-08-61 (without Plant STOP)

	ATEX / IECEx						NEC 505						NEC 506						NEC 500					
	0	1	2	20	21	22	Zone	0	1	2	20	21	22	Division	1	2	1	2	1	2				
Ex interface	x	x	x	x	x	x	Ex interface	x	x	x	x	x	x	Ex interface	x	x	x	x	x	x	x			
Installation in		x	x		x	x	Installation in		x	x		x	x	Installation in	x	x	x	x	x	x	x			

WebCode 9475C

Digital Output Module 8-Channel Version for Zone 1

Series 9475/32-08-.2



Explosion Protection

Global (IECEX)

Gas and dust	IECEX DEK 12.0070X Ex ia [ia Ga] IIC T4 Gb [Ex ia Da] IIIC
--------------	--

Europe (ATEX)

Gas and dust	DEKRA 12 ATEX0232X ⊕ II 2 (1) G Ex ia [ia Ga] IIC T4 Gb ⊕ II (1) D [Ex ia Da] IIIC
--------------	--

Certifications and certificates

Certificates	ATEX, IECEX, Brazil (INMETRO), Canada (cFM), Russia (GOST R), USA (FM), Belarus (operating authorisation)
Ship approval	ABS, BV, ClassNK, DNVGL, LR, RS

Further parameters

Installation	in Zone 1, Zone 2, Zone 21, Zone 22 and in the safe area
Further information	see respective certificate and operating instructions

Safety data

Design	9475/32-08-52							
Max. voltage U_o	19.4							
Output ia								
Max. current I_o	143 mA							
Max. power P_o	692 mW							
Max. connectable inductance L_o / capacity C_o								
IIC	L_o [mH]	1.44	1.4	0.65	0.5	0.2	0.1	0.05
	C_o [nF]	--	103	113	113	153	183	227
IIB / IIIC	L_o [mH]	7.5	5.0	2.0	0.5	0.2	0.1	0.02
	C_o [nF]	673	883	943	943	1083	1283	1493
Output ib								
Max. current I_o	37.8 mA							
Max. power P_o	506 mW							
Max. connectable inductance L_o / capacity C_o								
IIC	L_o [mH]	6.3	2.0	0.65	0.5	0.2	0.1	0.05
	C_o [nF]	113	113	123	123	153	193	227
IIB / IIIC	L_o [mH]	58	20	10	5.0	0.2	0.1	0.02
	C_o [nF]	363	723	953	963	1083	1283	1493
Max. internal capacity C_i	5.2 nF (in the above tables, C_i is subtracted from C_o)							
Max. internal inductance L_i	negligible							

Digital Output Module 8-Channel Version for Zone 1

Series 9475/32-08-.2



Explosion Protection

Safety data

Design

9475/32-08-62

Max. voltage U_o

25.7

Output ia

Max. current I_o

107 mA

Max. power P_o

688 mW

Max. connectable inductance L_o / capacity C_o

IIC

L_o [mH]	1.57	1.1	1.0	0.9	0.5	0.2	0.1
------------	------	-----	-----	-----	-----	-----	-----

C_o [nF]	--	49	52	54	69	95	97
------------	----	----	----	----	----	----	----

IIB / IIIC

L_o [mH]	11	5.0	1.0	0.5	0.2	0.1	0.05
------------	----	-----	-----	-----	-----	-----	------

C_o [nF]	335	335	395	485	635	785	785
------------	-----	-----	-----	-----	-----	-----	-----

Output ib

Max. current I_o

26.3 mA

Max. power P_o

468 mW

Max. connectable inductance L_o / capacity C_o

IIC

L_o [mH]	7.0	5.0	2.0	1.0	0.5	0.2	0.05
------------	-----	-----	-----	-----	-----	-----	------

C_o [nF]	32	36	49	64	81	97	97
------------	----	----	----	----	----	----	----

IIB / IIIC

L_o [mH]	100	50	1.0	0.5	0.2	0.1	0.05
------------	-----	----	-----	-----	-----	-----	------

C_o [nF]	245	365	425	505	655	785	785
------------	-----	-----	-----	-----	-----	-----	-----

Max. internal capacity C_i

5.2 nF (in the above tables, C_i is subtracted from C_o)

Max. internal inductance L_i

negligible

Ex i control input "Pant STOP"

Connection terminals

X3 1, 2
(without galvanic separation, 9475/22 compatible)

X3 3, 4
(with galvanic separation, switchable in parallel)

Type of protection

Ex ia

Ex ia

Max. voltage U_o

5.1 V

--

Max. current I_o

0.44 mA

--

Max. power P_o

0.5 mW

--

Max. connectable inductance L_o /capacity C_o

IIC

L_o [mH]	100	10	2	1	0.2	0.01
------------	-----	----	---	---	-----	------

C_o [μF]	2.195	2.595	3.295	3.695	5.495	15.995
------------	-------	-------	-------	-------	-------	--------

--

IIB / IIIC

L_o [mH]	100	10	2	1	0.2	0.01
------------	-----	----	---	---	-----	------

C_o [μF]	9.995	12.995	16.995	19.995	31.995	159.995
------------	-------	--------	--------	--------	--------	---------

--

Max. voltage U_i

--

30 V

Max. internal resistance R_i

--

4940 Ω

Max. internal capacity C_i

5.2 nF (in the above tables, C_i is subtracted from C_o)

negligible

Max. internal inductance L_i

negligible

negligible

A4

Digital Output Module 8-Channel Version for Zone 1

Series 9475/32-08-.2



Selection Table

Version	Open-circuit voltage	Max. output current	Internal resistance	Installation	Order number	Weight kg
Digital Output Module with "Plant STOP"	17.5 V	30 mA	170 Ω	Zone 1	9475/32-08-52	0.275
	23.5 V	20 mA	315 Ω	Zone 1	9475/32-08-62	0.275

Technical Data

Electrical data

Design

Ex i outputs

	9475/32-08-52
Number of channels	8
Open-circuit voltage	17.5 V
Output nominal current	30 mA
Internal resistance	170 Ω
Rated operation	
U	12.6 V
I	30 mA
Output characteristic	

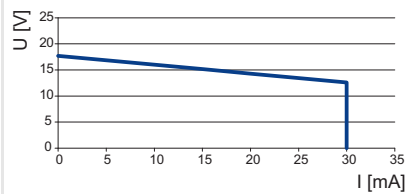

15283E00

9475/32-08-62

Number of channels	8
Open-circuit voltage	23.5 V
Output nominal current	20 mA
Internal resistance	315 Ω
Rated operation	
U	17.5 V
I	20 mA

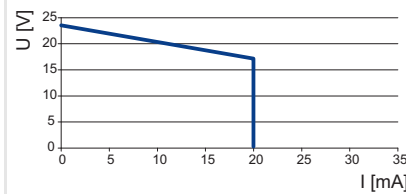

15284E00

Ex i control input X3

Function	"Plant STOP" to switch off all outputs
Suitability	Switch-off up to SIL 2 (IEC61508)
Connection terminals	

	X3 1, 2 (without galvanic separation, 9475/22 compatible)	X3 3, 4 (with galvanic separation, switchable in parallel)
Supply voltage	3.3 V	--
Internal resistance	20.5 kΩ	--
Control voltage for all outputs		
„OFF“ („Plant-STOP“ activated)	> 2.2 V	< 1 V
„Normal operation“ („Plant-STOP“ deactivated)	< 0.7 V	> 6 V

Galvanic separation

Test voltage

acc. to standard	EN 60079-11
Between auxiliary power/system components	≥ 1500 V AC
Between two I/O modules	≥ 500 V AC
Between I/O channels/system components	≥ 500 V AC
Between I/O channels/ground (PA)	≥ 500 V AC
Between I/O channels/"Plant STOP" (X3 3, 4)	≥ 500 V AC
Between "Plant STOP" (X3 3, 4)/earth (PA)	≥ 500 V AC

Electromagnetic compatibility

Tested to the following standards and regulations:
EN 61326-1 (2006) IEC 61000-4-1 ... 6, NAMUR NE 21

Digital Output Module 8-Channel Version for Zone 1

Series 9475/32-08-.2



Electrical data	
Electrical connection	BusRail Types 9494
Power supply	Pluggable, blue terminals, 16-pole, 2.5 mm ² , screw or spring type version with lock
Ex i field signals	Pluggable, blue terminal, 2-pole, 2.5 mm ² , screw type version with lock
Ex i control input	
Auxiliary power	
Version	Intrinsically safe Ex ia via BusRail
Behaviour during undervoltage	all outputs "OFF"
Max. current consumption	250 mA
Max. power consumption	6 W
Max. power dissipation	4.8 W
	Intrinsically safe Ex ia via BusRail
	all outputs "OFF"
	240 mA
	5.8 W
	4 W
Device-specific data	
Settings	
Module	
Diagnosis messages	ON / OFF
Signal	
Line fault monitoring	ON / ON without test current / OFF
Behaviour in case of error	ON / OFF / hold last value
Ambient conditions	
Ambient temperature	-40 ... +75 °C (observe operating instructions)
Storage temperature	-40 ... +80 °C
Maximum relative humidity	95 % (without condensation)
Semi-sinusoidal shock (IEC EN 60068-2-27)	15 g (3 shocks per axis and direction)
Sinusoidal vibration (IEC EN 60068-2-6)	1 g in the frequency range 10 ... 500 Hz 2 g in the frequency range 45 ... 100 Hz
Mechanical data	
Degree of protection (IEC 60529)	IP20
Module enclosure	polyamide 6GF
Fire resistance (UL 94)	V2
Pollutant class	corresponds to G3
Dimensions	L = 128 mm, W = 96.5 mm, H = 67 mm
Indication	
LED indication	
Module requires maintenance	LED "M/S", blue
Operating state	LED "RUN", green
Group error	LED "ERR", red
Channel error	LED red, for each channel
Channel status	LED yellow, for each channel
"Plant STOP"	LED yellow ("Plant STOP" active, all outputs are high-impedance)
Function indication	
Retrievable parameters	Manufacturer, Type, hardware revision, software revision, serial number
Error indication	
Module status and alarms	<ul style="list-style-type: none"> • Internal bus error primer / redundant • No response from IOM • Configuration does not correspond to the module • Hardware error • Excess temperature • Slot error • Module requires maintenance
Signal errors for each channel	
Signal status bit	"0" = output high-impedance / "1" = output is supplied
Wire breakage output	> 12 kΩ (with deactivated test current can be detected only if the output is switched on)
Short circuit output	< 30 Ω (response range 30 ... 60 Ω) (can be detected only if the output is switched on)
Mounting / Installation	
Mounting orientation	horizontal or vertical (observe operating instructions)
Mounting type	on 35 mm DIN rail NS 35/15 (DIN EN 60715)

A4

Digital Output Module 8-Channel Version for Zone 1

Series 9475/32-08-.2





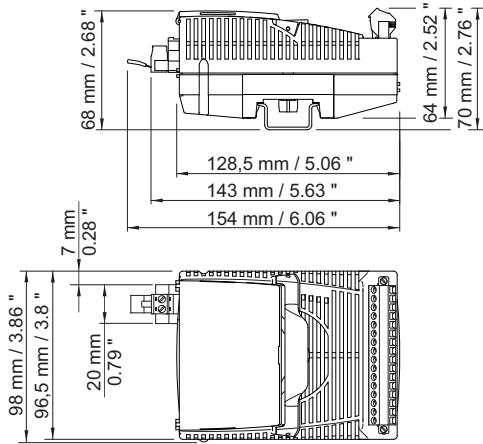



Dimensional drawings (all dimensions in mm / inches) - subject to modifications

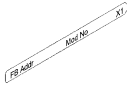

10989E00

Accessories and Spare Parts



Designation	Figure	Description	Art. no.
Pluggable terminal	 02079E00	2.5 mm ² with lock, 16-pole, screw connector, blue, for connecting the field signals to I/O modules, for intrinsically safe field circuits Labelling: 1 ... 16 Attention: An additional terminal is necessary for I/O module Series 9470 and 9480. Designation: 17 ... 32	162702
	 02077E00	2.5 mm ² with lock, 16-pole, spring clamp connection, blue, for connecting the field signals to I/O modules, for intrinsically safe field circuits, incl. test jacks Labelling: 1 ... 16 Attention: An additional terminal is necessary for I/O module Series 9470 and 9480. Designation: 17 ... 32	162695
mA - Isolating Repeater	 10389E00	The mA isolating repeaters are used for the connection of 4-wire transmitters to active 2-wire inputs and for the galvanic separation. Input: sink, Ex e Output: sink, Ex i	160166
	 04653E00	The mA isolating repeaters are used for the connection of 4-wire transmitters to active 2-wire inputs and for the galvanic separation. Input: sink, Ex i Output: sink, Ex i	160165
Labelling strips	 05869E00	"FB Addr ... Mod No ..." for pluggable terminal, sheet with 26 strips	162788
DIN A4 sheet	 09900E00	For label plate on I/O modules; 6 labels on each sheet; print-out using IS Wizard; packaging unit = 20 sheets	162832

Digital Output Module 8-Channel Version for Zone 1

Series 9475/32-08-.2



Accessories and Spare Parts

Designation	Figure	Description	Art. no.
Partition	 15198E00	For mounting between intrinsically safe and non-intrinsically safe connections of the I/O modules, in order to adhere to the required 50 mm distance	220101
Warning sign	 05872E00	"Clean modules only with a damp cloth."	162796

We reserve the right to make alterations to the technical data, dimensions, weights, designs and products available without notice. The illustrations cannot be considered binding.