

Type 6518/6519 can be combined with...

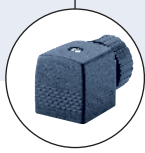

**Type 2508**  
Cable plug



**Type 1078**  
Timer unit

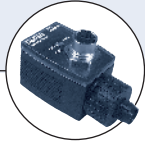

**Type 2512/2511**  
ASI cable plug

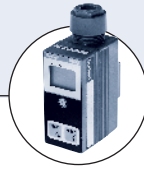

**Type 8600**  
Dosing control

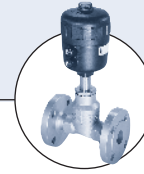

**Type 2012**  
Single-seat globe valve

- High flow-rate capacity
- Single or manifold mounting
- Circuit function NC and NO
- 3 and 5-way valves can be combined
- Push-over solenoid coil
- Reduced power consumption
- 

The Type 6518 is a 3/2-way valve and the Type 6519 is a 5/2 or 5/3-way valve. Together, they form a product line. Both types can be mounted on a pneumatic module. The valves can be used individually or in blocks.

Power consumption		
Inrush	Hold	
AC	AC	DC
[VA]	[VA/W]	[W]
11	6/2	2

Technical data	
<b>Orifice</b>	
Type 6518	DN 8.0 mm
Type 6519	DN 8.0 and 9.0 mm
<b>Body material</b>	
Type 6518	Polyamide, reinforced
Type 6519	Polyamide (5/2-way), aluminium (5/3-way)
<b>Thread insert material</b>	Brass (stainless steel on request)
<b>Seal material</b>	
Type 6518	NBR and PUR
Type 6519	NBR or NBR and PUR
<b>Media</b>	Compressed air, neutral gases
<b>Media temperature</b>	14°F to 122°F (-10°C to +50°C)
<b>Ambient temperature</b>	-13°F to 131°F (-25°C to +55°C)
<b>Supply ports</b>	
Type 6518: 1 and 3	NPT 1/4, can also be flanged
Type 6519: 1, 3 and 5	NPT 1/4, can also be flanged
<b>Service port</b>	
Type 6518: 2	Threaded port NPT 1/4
Type 6519: 2 and 4	Threaded port NPT 1/4
<b>Voltage tolerance</b>	±10%
<b>Duty cycle</b>	100% continuous rating
<b>Electrical connection</b>	Tag connector acc. to DIN 43650 Form A
<b>Protection class</b>	IP 65 with cable plug
<b>Installation</b>	As required, preferably with actuator upright

Dimensions [mm]

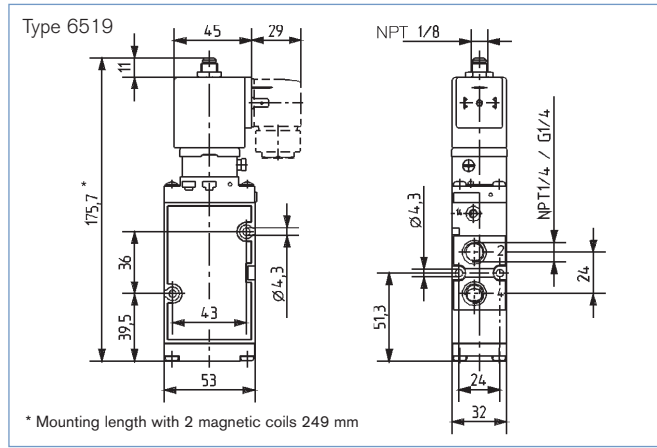
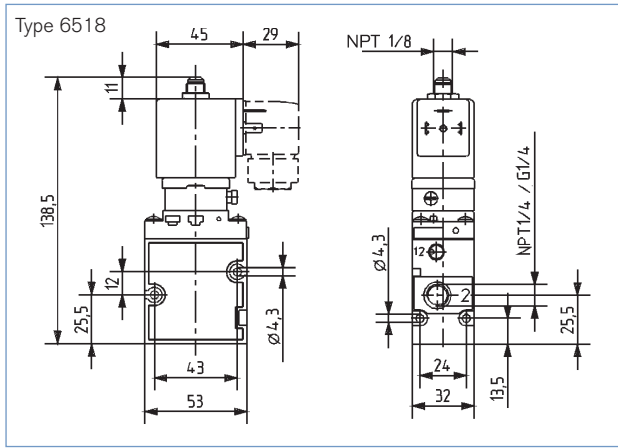

Ordering chart for Type 6518 valves (other versions on request)

All valves can be stand alone or mounted on a manifold. Includes standard cable plug Type 2508, 008 376 N

Circuit function	Orifice [mm]	Seal material body	Port connection threaded port	QNn value air [l/min]	Cv	Pressure range [PSI]	Power consumption [W]	Voltage/frequency [V/Hz]	Item no. UL Recognized CSA/CE
<b>C</b> 3/2-way valve NC 	8.0	NBR and PUR (polyamide)	NPT 1/4	1300	1.3	29 – 116	2	024/DC	456 989 T
								024/60	456 990 Y
								120/60	456 991 M
								240/60	456 992 N
<b>D</b> 3/2-way valve NO 	8.0	NBR and PUR (polyamide)	NPT 1/4	1300	1.3	29 – 116	2	024/DC	456 993 P
								024/60	456 994 Q
								120/60	456 995 R
								240/60	456 996 J

NOTE: UL listed/FM Class 1, Div 2 / CSA/CE on request

Ordering chart for Type 6519 valves (other versions on request)

All valves can be stand alone or mounted on a manifold. Includes standard cable plug Type 2508, 008 376 N

Circuit function	Orifice [mm]	Seal material body	Port connection threaded port	QNn value air [l/min]	Cv	Pressure range [PSI]	Power consumption [W]	Voltage/frequency [V/Hz]	Item no. UL Recognized CSA/CE
<b>H</b> 5/2-way valve 	8.0	NBR and PUR (polyamide)	NPT 1/4	1300	1.3	29 – 116	2	024/DC	456 977 W
								024/60	456 978 F
								120/60	456 979 G
								240/60	456 980 W
<b>L</b> 5/3-way valve Closed middle position 	8.0	NBR and PUR (polyamide)	NPT 1/4	1300	1.3	43 – 145	2	024/DC	456 981 K
								024/60	456 982 L
								120/60	456 983 M
								240/60	456 984 N
<b>N</b> 5/3-way valve, Vented middle position 	8.0	NBR and PUR (polyamide)	NPT 1/4	1300	1.3	43 – 145	2	024/DC	456 985 P
								024/60	456 986 Q
								120/60	456 987 R
								240/60	456 988 S

NOTE: UL listed/FM Class 1, Div 2 / CSA/CE on request

Manifold assembly with modules Type MP07 (example)

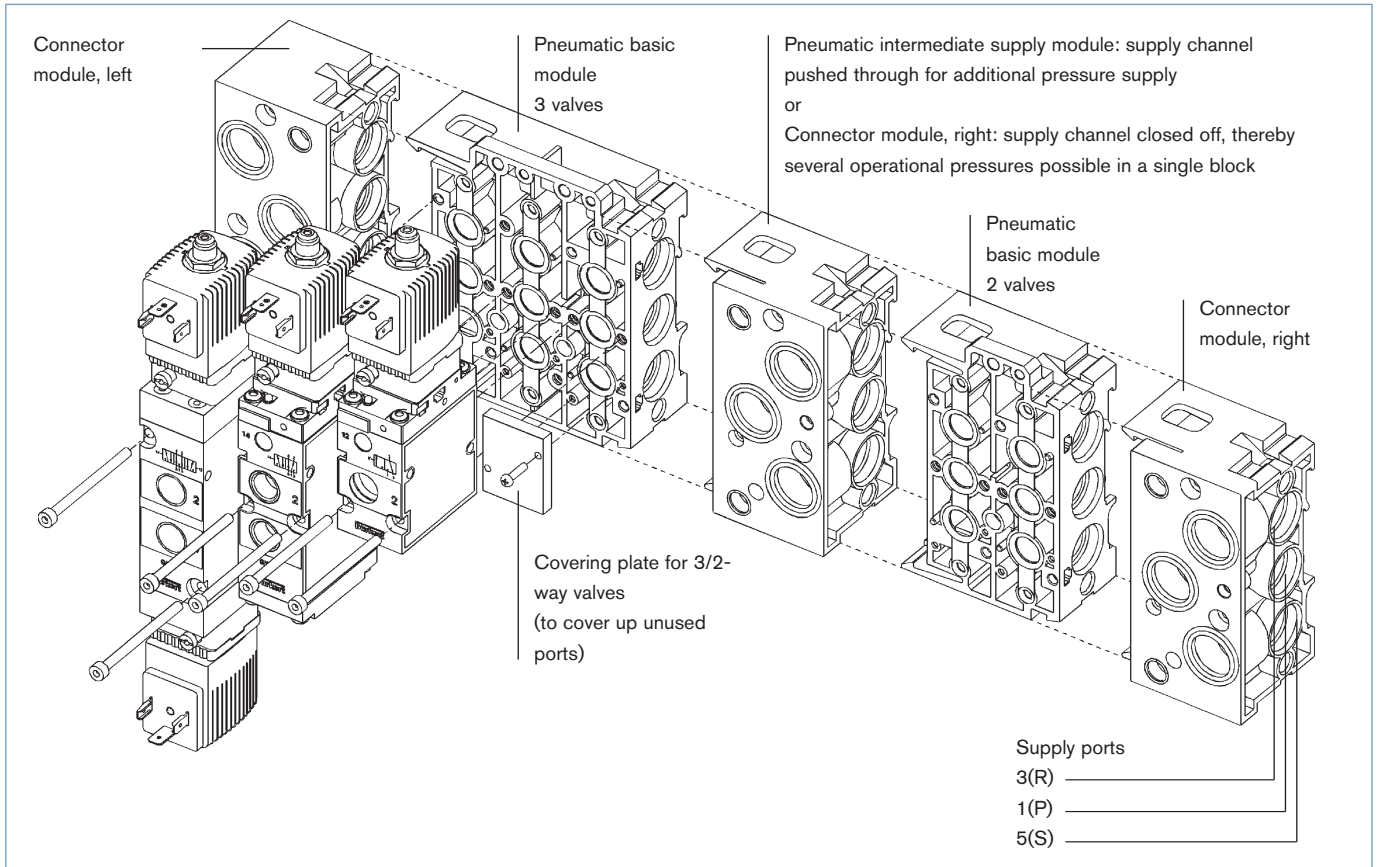

Manifold assembly either wall-mounted or standard mounting EN 50022 or 50023

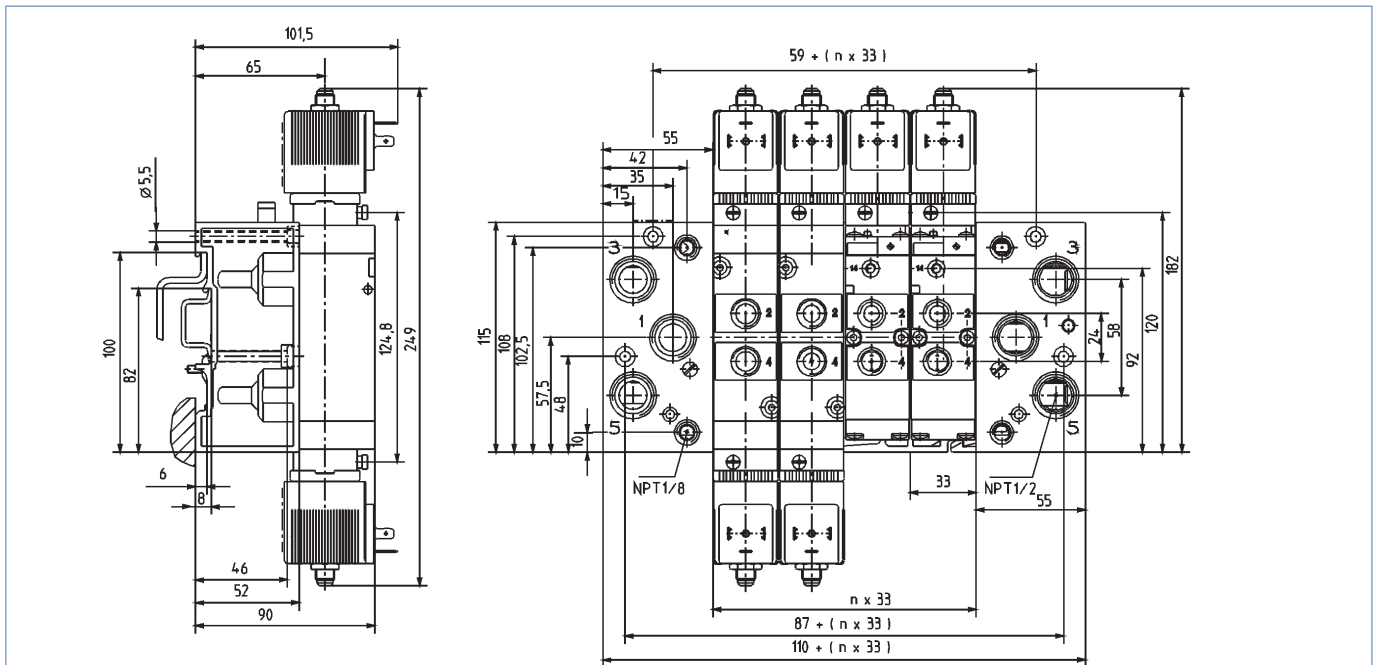

Valve assembly of the Type MP07 pneumatic modules using the supplied M4 screws.  
(n = no. of valves, max. 12)

DTS 1000082453 EN Version: C Status: RL (released | freigegeben | valide) printed: 29.08.2013

## Ordering chart for Type MP07 pneumatic module and complementary products

Version	Item no.
Connector module, right NPT 1/2	639 618 M
Pneumatic intermediate supply module	637 505 T
Pneumatic basic module 2 valves universal (for 3/2-, 5/2-, 5/3-way)	635 319 D
Pneumatic basic module 3 valves universal (for 3/2-, 5/2-, 5/3-way)	635 342 C
Connector module, left NPT 1/2	639 616 B
Covering plate for 5/2 and 5/3 (to cover the unused valve positions)	635 335 V
Covering plate für 3/2 (to cover the unused connections)	635 337 X
Blanking plug NPT 1/8, brass, Hex socket	US07133
Blanking plug NPT 1/4, brass, Hex socket	US00667
Blanking plug NPT 1/2, brass, Hex socket	US07129

**Note:** Manifold also can be used with FM approved explosion proof valves. Manifolds can not be used with ATEX approved valves.

## Ordering chart for cable plug 2508

The delivery of a cable plug includes the flat seal and the fixing screw (galvanised and chrome-plated): In the case of stainless steel valves, we recommend a cable plug with a stainless steel screw (see ordering chart, without circuitry)

Voltage	Current rating	Item number without cable
Without circuitry, 2 pins + protective earth		
0 to 250 V/AC/DC mounting screw (standard)	max. 6 A	008 376 N
0 to 250 V/AC/DC with st. steel screw	max. 6 A	132 445 L
Without circuitry, 3 pins + protective earth		
0 to 250 V/AC/DC	max. 6 A	008 526 V
With LED		
12 to 24 V/AC/DC	max. 6 A	008 360 S
100 to 120 V/AC/DC	max. 6 A	008 361 P
200 to 240 V/AC/DC	max. 6 A	008 362 Q
With rectifier, varistor and LED ■		
12 to 24 V/AC/DC	max. 1 A	008 363 R
100 to 120 V/AC/DC	max. 1 A	008 365 K
200 to 240 V/AC/DC	max. 1 A	008 366 L

■ With DC, ensure correct polarity.

## Ordering chart for cable plug 2508

The delivery of a cable plug includes the flat seal and fixing screw.

Voltage	Current rating	Item number without cable
With LED and varistor		
12 to 24 V /AC/DC	max. 6 A	008 376 N
100 to 120 V /AC/DC	max. 6 A	008 368 W
200 to 240 V/AC/DC	max. 6 A	008 369 X
With varistor		
12 to 24 V/AC/DC	max. 6 A	008 370 U
100 to 120 V/AC/DC	max. 6 A	008 371 J
200 to 240 V/AC/DC	max. 6 A	008 372 K
With pole protection, rectifier and LED		
12 to 24 V/DC	max. 1 A	008 373 K
With pole protection and rectifier		
12 to 240 V/DC	max. 1 A	008 375 M
With rectifier and varistor		
12 to 240 V/AC/DC	max. 1 A	008 374 L

In case of special application conditions, please consult for advice.

We reserve the right to make technical changes without notice.

0703/2\_US-en\_1000082452