

## 3/2-way Solenoid Valve for pneumatics

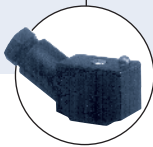

Type 6526 can be combined with...



**Type 2506**  
Cable plug



**Type 2510/2511**  
ASI cable plug

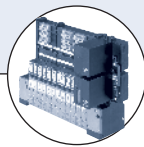

**Type 8640**  
Valve island



**Type 2031**  
Diaphragm valve

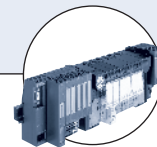

**Type 8644**  
Valve island

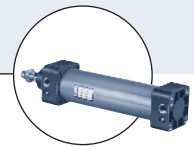

**Type 0044**  
Cylinder

- Compact design
- Single and manifold mounting
- Low power consumption
- Rocker pilot in DC
- Fast response times

The solenoid valve Type 6526 consists of a pneumatic valve body fitted with Type 6106 rocker pilot valve.

The rocker principle allows switching of high pressures together with low power consumption and fast response times. The extendable Type 6527 can be used for block modules (tag connectors in front) or for entire valve islands (8640 & 8644 - tag connectors at the block).

All valves are equipped with manual override as a standard.

Technical data	
<b>Orifice</b>	DN 6.0
<b>Body material</b>	PA (Polyamide)
<b>Seal material</b>	NBR
<b>Media</b>	Lubricated and non-lubricated dry air; neutral gases (10 µm filtering)
<b>Media temperature</b>	14°F to 122°F (-10°C to +50°C)
<b>Ambient temperature</b>	14°F to 131°F (-10°C to +55°C)
<b>Manual override</b>	As a standard feature
<b>Port connection</b>	Flange for MP12
<b>Pneumatic module</b>	Type MP12 with G1/8, Push-in connection Ø 8 mm
<b>Voltage tolerance</b>	±10%
<b>Voltage</b>	24 V DC
<b>Nominal power</b>	2W, 1W
<b>Duty cycle</b>	Continuous operation (100% ED)
<b>Electrical connection</b>	Tag connector acc. to DIN EN 175301-803 (previously DIN 43650) Form C
<b>Protection class</b>	IP 65 (with cable plug)
<b>Weight</b>	85g
<b>Mounting</b>	with 2 screws M3x30
<b>Installation</b>	As required, preferably with actuator upright

## Ordering chart for valves

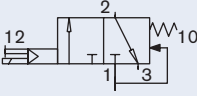
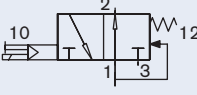
Circuit function	Orifice [mm]	C <sub>v</sub>	QnN value air [l/min]	Pressure range [PSI]	Nominal power [W]	Response time			Item no.
						Opening [ms]	Closing [ms] <sup>5)</sup>	Voltage/frequency [V/Hz]	
	6	0.64	700	14.5 - 145 <sup>1)</sup>	2	20	12	24 V DC	156 842 <sup>3)</sup>
				14.5 - 145 <sup>1)</sup>	2	20	12	24 V DC	163 028 <sup>2), 3)</sup>
				29 - 145	2	20	12	24 V DC	156 318 <sup>3)</sup>
				29 - 145	2	20	12	24 V DC	158 944 <sup>2), 3)</sup>
				29 - 145	2	20	12	24 V DC	160 405 <sup>2), 4)</sup>
				29 - 116	1	20	17	24 V DC	156 840 <sup>3)</sup>
				29 - 116	1	20	12	24 V DC	158 947 <sup>2), 3)</sup>
				29 - 116	1	20	12	24 V DC	160 408 <sup>2), 4)</sup>
	6	0.64	700	14.5 - 145 <sup>1)</sup>	2	12	20	24 V DC	157 672 <sup>3)</sup>
				14.5 - 145 <sup>1)</sup>	2	20	12	24 V DC	163 029 <sup>2), 3)</sup>
				29 - 145	2	12	20	24 V DC	156 320 <sup>3)</sup>
				29 - 145	2	20	12	24 V DC	158 946 <sup>2), 3)</sup>
				29 - 145	2	20	12	24 V DC	160 407 <sup>2), 4)</sup>
				29 - 116	1	17	20	24 V DC	156 841 <sup>3)</sup>
				29 - 116	1	20	12	24 V DC	158 948 <sup>2), 3)</sup>
				29 - 116	1	20	12	24 V DC	160 409 <sup>2), 4)</sup>

<sup>1)</sup> Version with auxiliary pilot air.

<sup>2)</sup> Electrical connection above manual override.

<sup>3)</sup> "long version": can be mounted together with type 6527 on a valve island.

<sup>4)</sup> "short version": cannot be combined with type 6527 on a valve island.

<sup>5)</sup> In combination with valve islands the closing time will be approx. 5ms longer.

<b>Flow rate</b> QnN-value air [l/min]	Measured at 68°F (+20°C), 87 PSI pressure at valve inlet and 14.5 PSI pressure difference
<b>Pressure values [bar]</b>	Measured as overpressure to the atmospheric pressure
<b>Response times [ms]</b>	Measures acc. to ISO 12238

Ordering chart for Type MP12 pneumatic modules

Module	Version	Feature	Item no.	
Connection module	right	G 3/8	655 110	
		NPT 3/8	655 112	
	left	G 3/8	655 109	
		NPT 3/8	655 111	
Pneumatic basic module 2 valves	push-in connection Ø 8 mm	without check valve	156 617	
		with integrated check valve with R-channel	156 635	
		with integrated check valve with R and S-channel	156 632	
		connection G 1/8	without check valve	156 620
			with integrated check valve with R-channel	156 636
			with integrated check valve with R and S-channel	156 633
	connection NPT 1/8	without check valve	156 631	
		with integrated check valve with R-channel	156 637	
		with integrated check valve with R and S-channel	156 634	
	Pneumatic basic module 4 valves	push-in connection Ø 8 mm	without check valve	156 656
			with integrated check valve with R-channel	156 662
			with integrated check valve with R and S-channel	156 659
connection G 1/8			without check valve	156 657
			with integrated check valve with R-channel	156 663
			with integrated check valve with R and S-channel	156 660
NPT 1/8		without check valve	156 658	
		with integrated check valve with R-channel	156 664	
		with integrated check valve with R and S-channel	156 661	
Covering plate			for unused valve positions	653 765

Dimensions [mm]

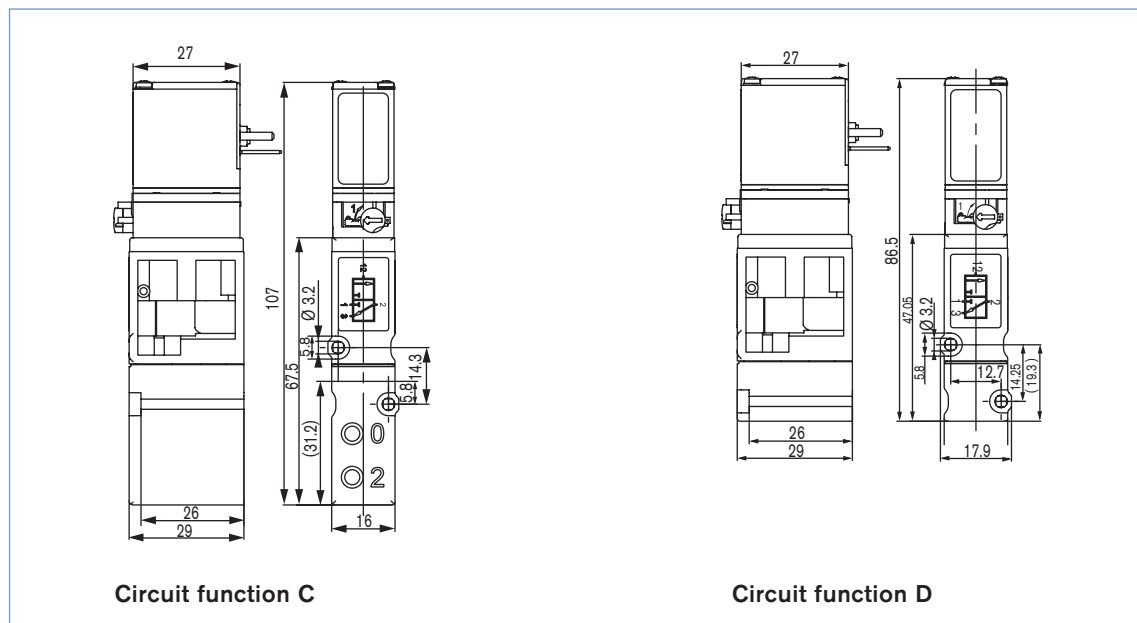

## Application example

14 Actuators (process valves, cylinder) are controlled

8 double acting actuators (large volume)

6 double acting actuators (small volume)

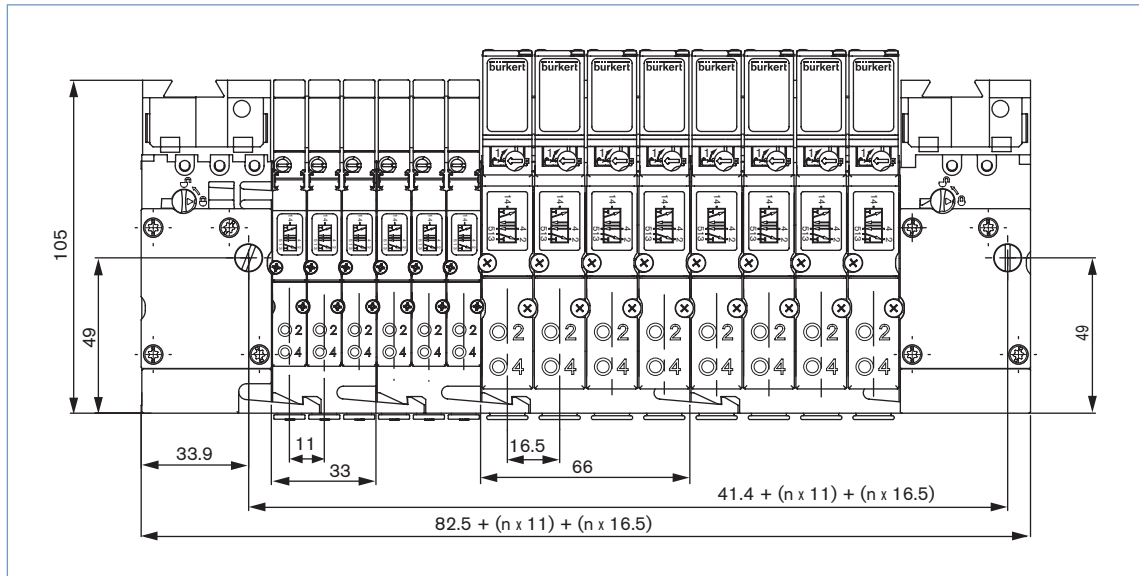

Quantity	Type	Version	Item no.
1	MP12	Connection module, right G 3/8	655 110
2	MP12	Pneumatic basic module, 4 valves, push-in connection Ø 8 mm	156 656
2	MP12 for Type 6525	Pneumatic basic module, 3 valves, push-in connection Ø 6 mm	156 647
1	MP12	Connection module, left G 3/8	655 109
8	6527	5/2-way- valve, WWC, QNn 700 l/min	156 827
6	6525	5/2-way- valve, WWC, QNn 300 l/min	156 733

Sectional drawing

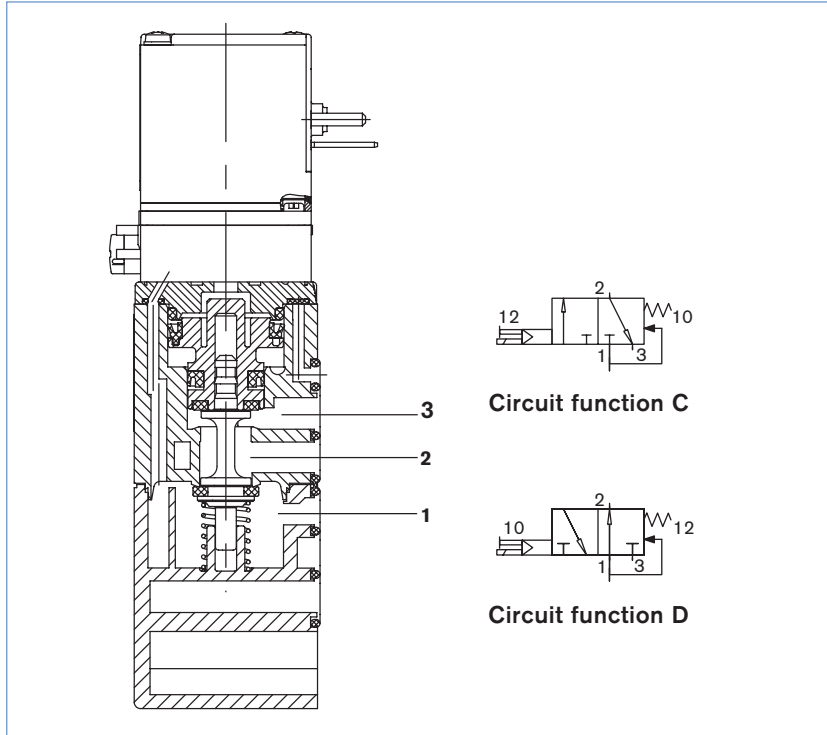

DTS 1000112363 EN Version: - Status: RL (released | freigegeben | valide) printed: 29.08.2013

Accessories ordering chart for pneumatic modules Type MP12

Built-in circuitry	Voltage [V]	Supply voltage	Item no.
without built-in circuitry	0 - 250 V	DC	008 353
with LED	12 - 24 V	DC	008 402
with LED and varistor	12 - 24 V	DC	008 408
with rectifier, LED and varistor	12 - 24 V	AC/DC	008 354
with rectifier, LED and varistor	110 - 120 V	AC/DC	008 355
with rectifier, LED and varistor	220 - 240 V	AC/DC	008 356

Additional versions please see datasheets for Type 2506

The delivery of a socket connection includes the flat seal and the mounting screw. For other socket connection models with integrated circuitry to DIN EN 175301-803 (previously DIN 43650) Form C, see datasheet 2506.

