

Datasheet

The Sure Cross® wireless system is a radio frequency network with integrated I/O that can operate in most environments and eliminate the need for wiring runs. Wireless networks are formed around a Gateway, which acts as the wireless network master device, and one or more Nodes.



- Wireless industrial I/O device with four selectable discrete inputs, four sourcing discrete outputs, two universal analog inputs, and two 0 to 20 mA analog outputs
- Selectable transmit power levels of 250 mW or 1 Watt for 900 MHz models and 65 mW for 2.4 GHz models
- 10 to 30 V dc power input
- DIP switches for user configuration
- Frequency Hopping Spread Spectrum (FHSS) technology and Time Division Multiple Access (TDMA) control architecture ensure reliable data delivery within the unlicensed Industrial, Scientific, and Medical (ISM) band
- Transceivers provide bidirectional communication between the Gateway and Node, including fully acknowledged data transmission
- Lost RF links are detected and relevant outputs set to user-defined conditions

For additional information, updated documentation, and accessories, refer to Banner Engineering's website, www.bannerengineering.com/surecross.

Models	Frequency	Environmental Rating	I/O
DX80N9X6S-P2	900 MHz ISM Band	IP67, NEMA 6	Inputs: Four selectable discrete, two 0 to 20 mA (default) or 0 to 10 V (user configurable) Outputs: Four sourcing discrete, two 0 to 20 mA
DX80N2X6S-P2	2.4 GHz ISM Band		



DX80...C (IP20; NEMA 1) models are also available. To order this model with an IP20 housing, add a C to the end of the model number: DX80N9X6S-P2C.



WARNING: Not To Be Used for Personnel Protection

Never use this device as a sensing device for personnel protection. Doing so could lead to serious injury or death. This device does not include the self-checking redundant circuitry necessary to allow its use in personnel safety applications. A sensor failure or malfunction can cause either an energized or de-energized sensor output condition.



CAUTION: Never Operate 1 Watt Radios Without Antennas

To avoid damaging the radio circuitry, never power up Sure Cross® Performance or Sure Cross MultiHop (1 Watt) radios without an antenna.



CAUTION: Electrostatic Discharge (ESD)

ESD Sensitive Device. This product uses semiconductors that can be damaged by electrostatic discharge (ESD). When performing maintenance, care must be taken so the device is not damaged. Disconnect power from the device when accessing the internal DIP switches. Proper handling procedures include wearing anti-static wrist straps. Damage from inappropriate handling is not covered by warranty.



Sure Cross® User Configuration Tool

The User Configuration Tool (UCT) software runs on any Windows machine and uses a converter cable to connect your Gateway to the computer.

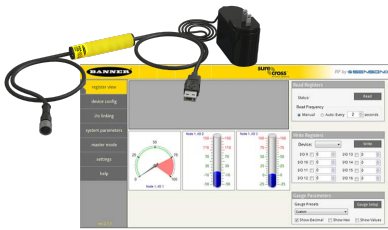

The User Configuration Tool (UCT) offers an easy way to link I/O points in your wireless network, view I/O register values graphically, and set system communication parameters when a host system is not part of the wireless network. Download the most recent revisions of the UCT software from Banner Engineering's website: <http://www.bannerengineering.com/wireless>.

The UCT requires a special USB to RS-485 (model number BWA-UCT-900 for 1 Watt radios, BWA-HW-006 can be used for all other radios) converter cable to pass information between your computer and the Gateway.

Setting Up Your Wireless Network

To set up and install your wireless network, follow these steps.

Disconnect the power from your Sure Cross devices.

1. Configure the DIP switches of all devices.
2. If your device has I/O, connect the sensors to the Sure Cross devices. If your device does not have I/O, skip this step.
3. Refer to the wiring diagrams to apply power to all devices.
 - For two LED models, the Gateway's LED 1 is solid green and the Node's LED 2 flashes red to indicate there is no radio link to the Gateway.
 - For one LED models, the Gateway's LED is solid green and the Node's LED flashes red to indicate there is no radio link to the Gateway.
4. Form the wireless network by binding the Nodes to the Gateway. If the binding instructions are not included in the datasheet, refer to the product manual for binding instructions.
5. Observe the LED behavior to verify the devices are communicating with each other.
 - For two LED models, the Gateway's LED 1 is solid green and the Node's LED 1 flashes green to indicate it is communicating with the Gateway.
 - For one LED models, the Gateway's LED is solid green and the Node's LED flashes green to indicate it is communicating with the Gateway.
6. Conduct a site survey between the Gateway and Nodes. If the site survey instructions are not included in this datasheet, refer to the product manual for detailed site survey instructions.
7. Install your wireless sensor network components. If installation instructions are not included in this datasheet, refer to the product manual for detailed installation instructions.

For additional information, including installation and setup, weatherproofing, device menu maps, troubleshooting, and a list of accessories, refer to one of the following product manuals.

- Sure Cross® Quick Start Guide: [128185](#)
- Sure Cross® Wireless I/O Network Instruction Manual: [132607](#)
- Web Configurator Instruction Manual (used with "Pro" and DX83 models): [134421](#)
- Host Controller Systems Instruction Manual: [132114](#)

Configure the DIP Switches

Before making any changes to the DIP switch positions, disconnect the power. DIP switch changes will not be recognized if power isn't cycled to the device.

For parameters not set via DIP switches, use the User Configuration Tool (UCT) to make configuration changes. For parameters set using the DIP switches, the DIP switch positions override any changes made using the User Configuration Tool.

Accessing the Internal DIP Switches

To access the internal DIP switches, follow these steps:

1. Unscrew the four screws that mount the cover to the bottom housing.
2. Remove the cover from the housing without damaging the ribbon cable or the pins the cable plugs into.
3. Gently unplug the ribbon cable from the board mounted into the bottom housing.

- Remove the black cover plate from the bottom of the device's cover.
The DIP switches are located behind the rotary dials.

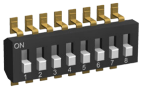

After making the necessary changes to the DIP switches, place the black cover plate back into position and gently push into place. Plug the ribbon cable in after verifying that the blocked hole lines up with the missing pin. Mount the cover back onto the housing.

DIP Switch Settings

Device Settings	Switches					
	1	2	3	4	5	6 ¹
900 MHz transmit power level: 1 Watt (30 dBm)	OFF*					
900 MHz transmit power level: 250 mW (24 dBm), DX80 compatibility mode	ON					
Modbus or UCT configured (overrides DIP switches 3-8)		OFF*				
DIP switch configured		ON				
Inputs sourcing (PNP)			OFF*			
Inputs sinking (NPN)			ON			
Link loss output: zero				OFF*	OFF*	
Link loss output: one				OFF	ON	
Link loss output: hold last state				ON	OFF	
Link loss output: user configuration				ON	ON	
0 to 20 mA scale						OFF*
4 to 20 mA scale						ON

* Default configuration

Analog Input and Output Scale

Use the DIP switch to select which current scale to use for all the device's analog inputs and outputs: 0 to 20 mA or 4 to 20 mA. When using a 4-20 mA sensor with a 0-20 mA input, the sensor uses the 4-20 mA section of the total range. Using a 4-20 mA with a 0-20 mA input allows you to determine when you have an error condition with the sensor. A normal input reading between 4 and 20 mA indicates a functioning sensor whereas a value below 4 mA indicates an error condition, such as a broken wire or loose connection. This DIP switch is used only on the 0 to 20 mA models, not the 0 to 10V models.

Discrete Input Type

Select the type of discrete input sensors to use with this device: sourcing (PNP) sensors or sinking (NPN) sensors.

Link Loss Outputs

The SureCross DX80 wireless devices use a deterministic radio link time-out method to address RF link interruption or failure. When a radio link fails, all pertinent wired outputs are sent to defined states until the link is recovered, ensuring that disruptions in the communications link result in predictable system behavior.

Following a radio link time-out, all outputs linked to the Node in question are set to de-energize (discrete outputs to zero, analog outputs to 0 mA or 4 mA), energize (discrete outputs to one, analog outputs to 20 mA), or to hold the last stable state/value. Use the DIP switches to select the link loss output state.

Modbus/User Configuration Tool (UCT) or DIP Switch Configured

In Modbus/UCT Configured mode, the device parameters are changed using the User Configuration Tool (UCT) or a Modbus command. All DIP switch positions are ignored. In DIP Switch Configured mode, use the DIP switches to configure the parameters listed in the table.

¹ Not used when configured for 0-10 V I/O.

Transmit Power Levels

The 900 MHz radios can be operated at 1 watt (30 dBm) or 250 mW (24 dBm). While the Performance radios operate in 1 Watt mode, they cannot communicate with the older 150 mW radios. To communicate with the older 150 mW radios, operate this radio in 250 mW mode. For 2.4 GHz models, this DIP switch is disabled. The transmit power for 2.4 GHz is fixed at about 65 mW EIRP (18 dBm), making the 2.4 GHz Performance models automatically compatible with older 2.4 GHz models.

Configuring Universal Analog Inputs for mA or V

To configure inputs to use 0 to 10V instead of 0 to 20mA, remove the installed resistors from the marked locations on the wiring board. For example, to make analog input 1 a 0 to 10V input, follow these instructions.

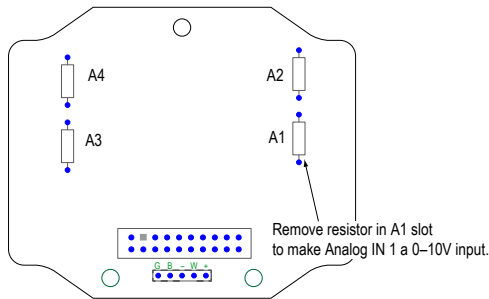

Step 1. Cut out the resistor installed in the A1 (analog 1) slot. (Your wiring board may differ slightly from the board shown. Use the board's labels to confirm you have selected the correct resistor to cut.)

Step 2. Launch the User Configuration Tool software.

Step 3. Change the units parameter for this particular input on this device (Gateway or Node) to use voltage instead of milliamps. Refer to the Modbus Register table for the I/O number for each analog input. Writing a four (4) to the Units parameter defines the units as 0 to 10V. Writing a two (2) to the Units parameter defines the units as 0 to 20 mA.

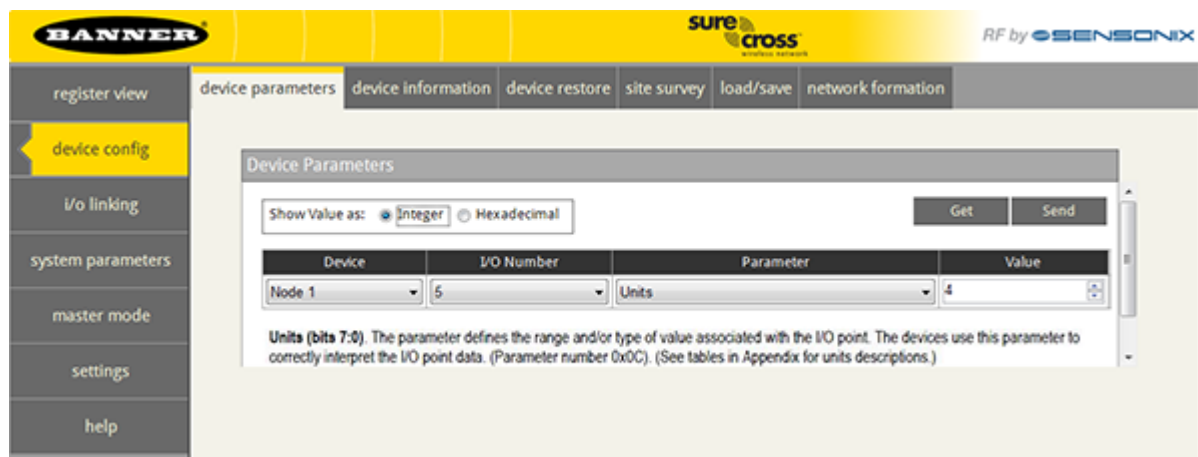

Note that a 220 ohm 0.1% resistor must be installed for a 0 to 20mA input. The resistor must be removed for an input defined as a 0 to 10V input.

Using Performance and Non-Performance Radios in the Same Network

To comply with federal regulations, the 150 mW radios and 1 Watt radios communicate differently. To mix Performance radios with non-Performance radios:

- Operate Performance radios in 250 mW mode to communicate with non-Performance radios (DIP switch 1 ON)
- Set non-Performance radios to use Extended Address Mode to communicate with Performance radios (DIP switch 1 ON)

For more detailed instructions about setting up your wireless network, refer to the Quick Start Guide (p/n [128185](#)). For more information about using Performance and non-Performance radios within the same network, refer the technical note titled *Mixing Performance Radios and 150 mW Radios in the Same Network* listed on the Wireless Support - FAQs section of Banner's [Wireless website](#).

Wiring Your Sure Cross® Device

Use the following wiring diagrams to first wire the sensors and then apply power to the Sure Cross devices.

5-Pin M12/Euro-style Male Quick Disconnect

Integral 5-pin M12/Euro-style male quick disconnect (QD) wiring depends on the model and power requirements of the device. Not all models can be powered by 10 to 30 V dc and not all models can be powered by 3.6 to 5.5 V dc. Refer to *Specifications* to verify the power requirements of your device. For FlexPower devices, do not apply more than 5.5 V to the gray wire.

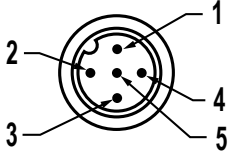
5-pin M12/Euro-style (male)	Pin	Wire Color	Powered by 10 to 30 V dc	Powered by Battery or Battery Pack
	1	Brown	10 to 30 V dc	
	2	White		
	3	Blue	dc common (GND)	dc common (GND)
	4	Black		
	5	Gray		3.6 to 5.5 V dc

Terminal Blocks

IP67 Housing (P2 Models)	IP20 Housing (P2C Models)
--------------------------	---------------------------

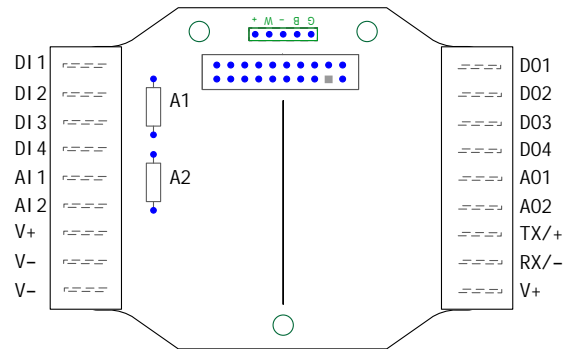
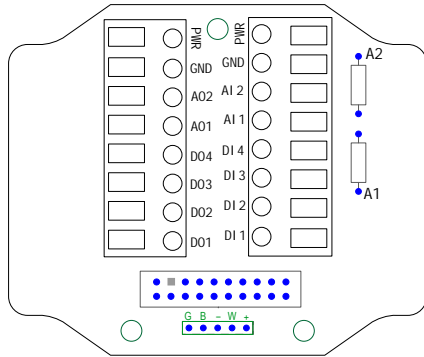

- AIx or Ax. Analog IN x
- AOx. Analog OUT x
- DIx. Discrete IN x
- DOx. Discrete OUT x
- GND. Ground/dc common connection
- PWR. 10 to 30 V dc power connection

- Rx/-. Serial communication line for the Gateway. No connection for Nodes
- Tx/+. Serial communication line for the Gateway; no connection for Nodes
- V+. 10 to 30 V dc power connection
- V-. Ground/dc common connection

DX80...C Wiring

Wiring power to the DX80...C models varies depending the power requirements of the model. Connecting dc power to the communication pins (Tx/Rx) causes permanent damage. For FlexPower devices, do not apply more than 5.5 V to the B+ terminal.

Terminal Label	Gateway and DX85	10 to 30 V dc Powered Nodes	Battery Powered Nodes
V+	10 to 30 V dc	10 to 30 V dc	
Tx/+	RS485 / D1 / B / +		
V-	dc common (GND)	dc common (GND)	dc common (GND)
Rx/-	RS485 / D0 / A / -		
B+			3.6 to 5.5 V dc

Wiring Diagrams for Discrete Inputs

Connecting dc power to the communication pins will cause permanent damage. For the DX8x...C models, PWR in the wiring diagram refers to V+ on the wiring board and GND in the wiring diagram refers to V- on the wiring board. To power the sensor using the switch power output (SPx), replace the PWR with SPx in these wiring diagrams.

Discrete Input Wiring for PNP Sensors

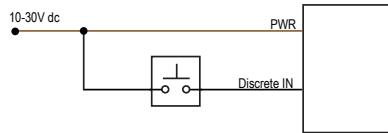

Discrete Input Wiring for NPN Sensors

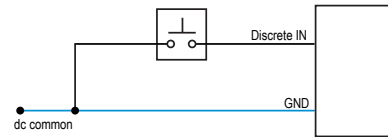

Wiring Diagrams for Discrete Outputs

Connecting dc power to the communication pins will cause permanent damage. For the DX8x...C models, PWR in the wiring diagram refers to V+ on the wiring board and GND in the wiring diagram refers to V- on the wiring board. To power the sensor using the switch power output (SPx), replace the PWR with SPx in these wiring diagrams.

Discrete Output Wiring (PNP)

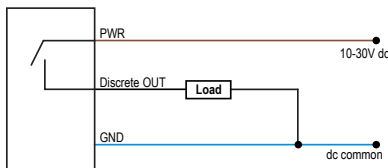

Wiring Diagrams for Analog Inputs

Connecting dc power to the communication pins will cause permanent damage. Do not exceed analog input ratings for analog inputs. Only connect sensor outputs to analog inputs.

Analog Input Wiring (10–30 V dc Power)

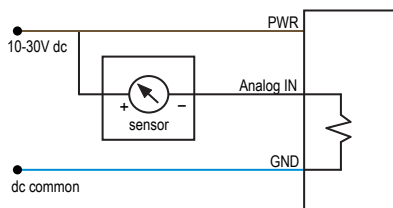

Analog Input Wiring (4–20 mA, 2-Wire, Externally-Powered Sensors)

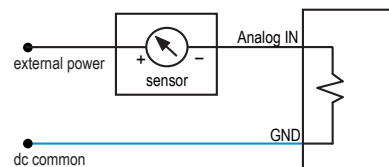

Wiring Diagrams for Analog Outputs

Connecting dc power to the communication pins will cause permanent damage.

Analog Output Wiring

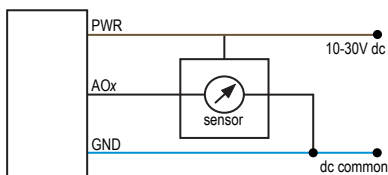

LED Behavior for the Nodes

Nodes do not sample inputs until they are communicating with the Gateway. The radios and antennas must be a minimum distance apart to function properly. Recommended minimum distances are:

- 2.4 GHz 65 mW radios: 1 foot
- 900 MHz 150 mW radios: 6 feet
- 900 MHz 1 Watt radios: 15 feet

LED 1	LED 2	Node Status
Flashing green		Radio Link Ok
Flashing red	Flashing red	Device Error
	Flashing red, 1 per 3 sec	No Radio Link

Modbus Register Table

I/O	Modbus Holding Register		I/O Type	Units	I/O Range		Holding Register Representation	
	Gateway	Any Node			Min. Value	Max. Value	Min. (Dec.)	Max. (Dec.)
1	1	1 + (Node# × 16)	Discrete IN 1	-	0	1	0	1
2	2	2 + (Node# × 16)	Discrete IN 2	-	0	1	0	1
3	3	3 + (Node# × 16)	Discrete IN 3	-	0	1	0	1
4	4	4 + (Node# × 16)	Discrete IN 4	-	0	1	0	1
5	5	5 + (Node# × 16)	Analog IN 1	mA	0.0	20.0	0	65535
				V	0.0	10.0		
6	6	6 + (Node# × 16)	Analog IN 2	mA	0.0	20.0	0	65535
				V	0.0	10.0		
7	7	7 + (Node# × 16)	Reserved					
8	8	8 + (Node# × 16)	Device Message					
9	9	9 + (Node# × 16)	Discrete OUT 1	-	0	1	0	1
10	10	10 + (Node# × 16)	Discrete OUT 2	-	0	1	0	1
11	11	11 + (Node# × 16)	Discrete OUT 3	-	0	1	0	1
12	12	12 + (Node# × 16)	Discrete OUT 4	-	0	1	0	1
13	13	13 + (Node# × 16)	Analog OUT 1	mA	0.0	20.0	0	65535
14	14	14 + (Node# × 16)	Analog OUT 2	mA	0.0	20.0	0	65535
15	15	15 + (Node# × 16)	Control Message					
16	16	16 + (Node# × 16)	Reserved					

Specifications

Radio Range²

- 900 MHz, 1 Watt: Up to 9.6 km (6 miles)
- 2.4 GHz, 65 mW: Up to 3.2 km (2 miles)

Minimum Separation Distance

- 900 MHz (1 Watt): 4.57 m (15 ft)
- 2.4 GHz (65 mW): 0.3 m (1 ft)

Radio Transmit Power

- 900 MHz, 1 Watt: 30 dBm (1 W) conducted (up to 36 dBm EIRP)
- 2.4 GHz, 65 mW: 18 dBm (65 mW) conducted, less than or equal to 20 dBm (100 mW) EIRP

900 MHz Compliance (1 Watt)

- FCC ID UE3RM1809: This device complies with FCC Part 15, Subpart C, 15.247
- IC: 7044A-RM1809

2.4 GHz Compliance

- FCC ID UE300DX80-2400 - This device complies with FCC Part 15, Subpart C, 15.247
- ETSI EN 300 328 V1.8.1 (2012-06)
- IC: 7044A-DX8024

Spread Spectrum Technology

- FHSS (Frequency Hopping Spread Spectrum)

Operating Conditions⁴

- 40 °C to +85 °C (-40 °F to +185 °F) (Electronics); -20 °C to +80 °C (-4 °F to +176 °F) (LCD)
- 95% maximum relative humidity (non-condensing)
- Radiated Immunity: 10 V/m (EN 61000-4-3)

Shock and Vibration

- IEC 68-2-6 and IEC 68-2-27
- Shock: 30g, 11 millisecond half sine wave, 18 shocks
- Vibration: 0.5 mm p-p, 10 to 60 Hz

Discrete I Inputs

- Four, DIP switch selectable between PNP and NPN
- Input Rating: 3 mA max current at 30 V dc
- Sample Rate: 62.5 milliseconds
- Report Rate: On change of state

Discrete I Input ON Condition

- PNP: Greater than 8 V
- NPN: Less than 0.7 V

Discrete I Input OFF Condition

- PNP: Less than 5 V
- NPN: Greater than 2 V or open

Analog I Inputs

- Two, 0 to 20 mA (default) or 0 to 10 V (user configurable)
- Input Rating (mA): 24 mA
- Input Rating (V): 10 V
- Impedance: Approx. 220 Ohms
- Sample Rate: 62.5 milliseconds
- Report Rate: 1 second or On Change of State (1% change in value)
- Accuracy: 0.2% of full scale +0.01% per °C
- Resolution: 12-bit

Supply Voltage

- 10 to 30 V dc (Outside the USA: 12 to 24 V dc, ±10%).³
- 900 MHz Consumption: Maximum current draw is < 40 mA and typical current draw is < 30 mA at 24 V dc. (2.4 GHz consumption is less.)

Housing

- Polycarbonate housing and rotary dial cover; polyester labels; EDPM rubber cover gasket; nitrile rubber, non-sulphur cured button covers
- Weight: 0.26 kg (0.57 lbs)
- Mounting: #10 or M5 (SS M5 hardware included)
- Max. Tightening Torque: 0.56 N·m (5 lbf·in)

Antenna Connection

- Ext. Reverse Polarity SMA, 50 Ohms
- Max Tightening Torque: 0.45 N·m (4 lbf·in)

Interface

- Indicators: Two bi-color LEDs
- Buttons: Two
- Display: Six character LCD

Wiring Access

- DX80 models: Four PG-7, One 1/2-inch NPT, One 5-pin threaded M12/Euro-style male quick disconnect
- DX80...C models: External terminals

Link Timeout

- Gateway: Configurable via User Configuration Tool (UCT) software
- Node: Defined by Gateway

Environmental Ratings⁵

- DX80 models: IEC IP67; NEMA 6
- "C" Housing Models/External wiring terminals: IEC IP20; NEMA 1

Certifications



Discrete Outputs

- Four PNP
- Update Rate: 125 milliseconds
- ON Condition: Supply minus 2 V
- OFF Condition: Less than 2 V

Discrete Output Rating (PNP)

- 100 mA max current at 30 V dc
- ON-State Saturation: Less than 3 V at 100 mA
- OFF-state Leakage: Less than 10 µA

Analog Outputs

- Two, 0 to 20 mA
- Update Rate: 125 milliseconds
- Accuracy: 0.1% of full scale +0.01% per °C
- Resolution: 12-bit

Output State Following Timeout

- De-energized (OFF)

Included with Model

The following items ship with the DX80 radios.

- BWA-HW-002: DX80 Access Hardware Kit, containing four PG-7 plastic threaded plugs, four PG-7 nylon gland fittings, four PG-7 hex nuts, one 1/2-inch NPT plug, and one 1/2-inch nylon gland fitting. (Not included with IP20 DX80...C models)
- BWA-HW-001: Mounting Hardware Kit, containing four M5-0.8 x 25mm SS screws, four M5-0.8 x 16mm SS screws, four M5-0.8mm SS hex nuts, and four #8-32 x 3/4" SS bolts
- BWA-HW-003: PTFE tape

² Radio range is with the 2 dB antenna that ships with the product. High-gain antennas are available, but the range depends on the environment and line of sight. To determine the range of your wireless network, perform a Site Survey.

³ For European applications, power the DX80 from a Limited Power Source as defined in EN 60950-1.

⁴ Operating the devices at the maximum operating conditions for extended periods can shorten the life of the device.

⁵ Refer to the [Sure Cross® Wireless I/O Networks Instruction Manual](#) (p/n 132607) for installation and waterproofing instructions.

- BWA-902-C (900 MHz) or BWA-202-C (2.4 GHz): Antenna, 2 dBd Omni, Rubber Swivel RP-SMA Male. (Not included with Internal antenna models)
- Quick Start Guide (128185 for DX80 Gateways or 152653 for MultiHop models)
- MQDC1-506: 5-Euro (single ended) straight cable, 2m (Not included with FlexPower devices)
- BWA-HW-011: IP20 Screw Terminal Headers (2 pack) (Included only with the IP20 DX80...C models)

Warnings

Antenna Installations. Install and properly ground a qualified surge suppressor when installing a remote antenna system. Remote antenna configurations installed without surge suppressors invalidate the manufacturer's warranty. Keep the ground wire as short as possible and make all ground connections to a single-point ground system to ensure no ground loops are created. No surge suppressor can absorb all lightning strikes; do not touch the Sure Cross® device or any equipment connected to the Sure Cross device during a thunderstorm.

Exporting Sure Cross® Radios. It is our intent to fully comply with all national and regional regulations regarding radio frequency emissions. Customers who want to re-export this product to a country other than that to which it was sold must ensure the device is approved in the destination country. A list of approved countries appears in the *Radio Certifications* section of the product manual. The Sure Cross wireless products were certified for use in these countries using the antenna that ships with the product. When using other antennas, verify you are not exceeding the transmit power levels allowed by local governing agencies. Consult with Banner Engineering Corp. if the destination country is not on this list.

Violating Warnings. The manufacturer does not take responsibility for the violation of any warning listed in this document. Make no modifications to this product; any modifications to this product not expressly approved by Banner Engineering could void the user's authority to operate the product. All specifications published in this document are subject to change; Banner reserves the right to modify product specifications or update documentation at any time. For the most recent version of any documentation, refer to: www.bannerengineering.com. © Banner Engineering Corp. All rights reserved.

Banner Engineering Corp. Limited Warranty

Banner Engineering Corp. warrants its products to be free from defects in material and workmanship for one year following the date of shipment. Banner Engineering Corp. will repair or replace, free of charge, any product of its manufacture which, at the time it is returned to the factory, is found to have been defective during the warranty period. This warranty does not cover damage or liability for misuse, abuse, or the improper application or installation of the Banner product.

THIS LIMITED WARRANTY IS EXCLUSIVE AND IN LIEU OF ALL OTHER WARRANTIES WHETHER EXPRESS OR IMPLIED (INCLUDING, WITHOUT LIMITATION, ANY WARRANTY OF MERCHANTABILITY OR FITNESS FOR A PARTICULAR PURPOSE), AND WHETHER ARISING UNDER COURSE OF PERFORMANCE, COURSE OF DEALING OR TRADE USAGE.

This Warranty is exclusive and limited to repair or, at the discretion of Banner Engineering Corp., replacement. IN NO EVENT SHALL BANNER ENGINEERING CORP. BE LIABLE TO BUYER OR ANY OTHER PERSON OR ENTITY FOR ANY EXTRA COSTS, EXPENSES, LOSSES, LOSS OF PROFITS, OR ANY INCIDENTAL, CONSEQUENTIAL OR SPECIAL DAMAGES RESULTING FROM ANY PRODUCT DEFECT OR FROM THE USE OR INABILITY TO USE THE PRODUCT, WHETHER ARISING IN CONTRACT OR WARRANTY, STATUTE, TORT, STRICT LIABILITY, NEGLIGENCE, OR OTHERWISE.

Banner Engineering Corp. reserves the right to change, modify or improve the design of the product without assuming any obligations or liabilities relating to any product previously manufactured by Banner Engineering Corp.