

Sure Cross® Performance Node with I/O Mapping



Datasheet

The Sure Cross® wireless system is a radio frequency network with integrated I/O that can operate in most environments and eliminate the need for wiring runs. Wireless networks are formed around a Gateway, which acts as the wireless network master device, and one or more Nodes.



WARNING: Not To Be Used for Personnel Protection

Never use this device as a sensing device for personnel protection. Doing so could lead to serious injury or death. This device does not include the self-checking redundant circuitry necessary to allow its use in personnel safety applications. A sensor failure or malfunction can cause either an energized or de-energized sensor output condition.



CAUTION: Never Operate 1 Watt Radios Without Antennas

To avoid damaging the radio circuitry, never power up Sure Cross® Performance or Sure Cross MultiHop (1 Watt) radios without an antenna.



CAUTION: Electrostatic Discharge (ESD)

ESD Sensitive Device. This product uses semiconductors that can be damaged by electrostatic discharge (ESD). When performing maintenance, care must be taken so the device is not damaged. Disconnect power from the device when accessing the internal DIP switches. Proper handling procedures include wearing anti-static wrist straps. Damage from inappropriate handling is not covered by warranty.

For additional information, updated documentation, and accessories, refer to Banner Engineering's website, www.bannerengineering.com/surecross.

Models	Frequency	Environmental Rating	I/O
DX80N9X6S-PM2	900 MHz ISM Band	IP67, NEMA 6	Inputs: Four selectable discrete, two 0–20 mA
DX80N2X6S-PM2	2.4 GHz ISM Band		Outputs: Four PNP discrete, two 0–20 mA analog
			I/O is automatically mapped to the PM2 Gateway using the Gateway's menu system



DX80...C (IP20; NEMA 1) models are also available. To order this model with an IP20 housing, add a C to the end of the model number: DX80N9X6S-PM2C.

Configure the DIP Switches

Before making any changes to the DIP switch positions, disconnect the power. DIP switch changes will not be recognized if power isn't cycled to the device.

Accessing the Internal DIP Switches

To access the internal DIP switches, follow these steps:

1. Unscrew the four screws that mount the cover to the bottom housing.
2. Remove the cover from the housing without damaging the ribbon cable or the pins the cable plugs into.
3. Gently unplug the ribbon cable from the board mounted into the bottom housing.



4. Remove the black cover plate from the bottom of the device's cover.
The DIP switches are located behind the rotary dials.

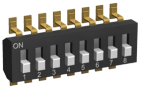

After making the necessary changes to the DIP switches, place the black cover plate back into position and gently push into place. Plug the ribbon cable in after verifying that the blocked hole lines up with the missing pin. Mount the cover back onto the housing.

DIP Switch Settings

Switches						
Device Settings	1	2	3	4	5	6 ¹
900 MHz transmit power level: 1 Watt (30 dBm)	OFF*					
900 MHz transmit power level: 250 mW (24 dBm), DX80 compatibility mode	ON					
Modbus or UCT configured (overrides DIP switches 3-8)		OFF*				
DIP switch configured		ON				
Inputs sourcing (PNP)			OFF*			
Inputs sinking (NPN)			ON			
Link loss output: zero				OFF*	OFF*	
Link loss output: one				OFF	ON	
Link loss output: hold last state				ON	OFF	
Link loss output: user configuration				ON	ON	
0 to 20 mA scale						OFF*
4 to 20 mA scale						ON

* Default configuration

Analog Input and Output Scale

Use the DIP switch to select which current scale to use for all the device's analog inputs and outputs: 0 to 20 mA or 4 to 20 mA. When using a 4-20 mA sensor with a 0-20 mA input, the sensor uses the 4-20 mA section of the total range. Using a 4-20 mA with a 0-20 mA input allows you to determine when you have an error condition with the sensor. A normal input reading between 4 and 20 mA indicates a functioning sensor whereas a value below 4 mA indicates an error condition, such as a broken wire or loose connection. This DIP switch is used only on the 0 to 20 mA models, not the 0 to 10V models.

Discrete Input Type

Select the type of discrete input sensors to use with this device: sourcing (PNP) sensors or sinking (NPN) sensors.

Link Loss Outputs

The SureCross DX80 wireless devices use a deterministic radio link time-out method to address RF link interruption or failure. When a radio link fails, all pertinent wired outputs are sent to defined states until the link is recovered, ensuring that disruptions in the communications link result in predictable system behavior.

Following a radio link time-out, all outputs linked to the Node in question are set to de-energize (discrete outputs to zero, analog outputs to 0 mA or 4 mA), energize (discrete outputs to one, analog outputs to 20 mA), or to hold the last stable state/value. Use the DIP switches to select the link loss output state.

Modbus/User Configuration Tool (UCT) or DIP Switch Configured

In Modbus/UCT Configured mode, the device parameters are changed using the User Configuration Tool (UCT) or a Modbus command. All DIP switch positions are ignored. In DIP Switch Configured mode, use the DIP switches to configure the parameters listed in the table.

¹ Not used when configured for 0-10 V I/O.

Transmit Power Levels

The 900 MHz radios can be operated at 1 watt (30 dBm) or 250 mW (24 dBm). While the Performance radios operate in 1 Watt mode, they cannot communicate with the older 150 mW radios. To communicate with the older 150 mW radios, operate this radio in 250 mW mode. For 2.4 GHz models, this DIP switch is disabled. The transmit power for 2.4 GHz is fixed at about 65 mW EIRP (18 dBm), making the 2.4 GHz Performance models automatically compatible with older 2.4 GHz models.

Wiring Your Sure Cross® Device

Use the following wiring diagrams to first wire the sensors and then apply power to the Sure Cross devices.

Terminal Blocks (PM2 and PM2C Models)

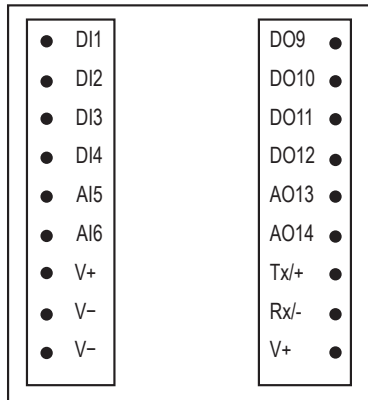

AIx. Analog IN x.

AOx. Analog OUT x.

DIx. Discrete IN x.

DOx. Discrete OUT x.

RX/-. Serial communication line for the Gateway. No connection for Nodes

TX/+. Serial communication line for the Gateway; no connection for Nodes

V+. 10 to 30 V dc power connection

V-. Ground/dc common connection

(-PM2 board shown)

Wiring Diagrams for Discrete Inputs

Connecting dc power to the communication pins will cause permanent damage. For the DX8x...C models, PWR in the wiring diagram refers to V+ on the wiring board and GND in the wiring diagram refers to V- on the wiring board. To power the sensor using the switch power output (SPx), replace the PWR with SPx in these wiring diagrams.

Discrete Input Wiring for PNP Sensors

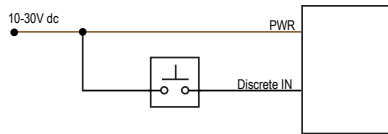

Discrete Input Wiring for NPN Sensors

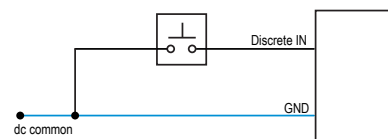

Wiring Diagrams for Discrete Outputs

Connecting dc power to the communication pins will cause permanent damage. For the DX8x...C models, PWR in the wiring diagram refers to V+ on the wiring board and GND in the wiring diagram refers to V- on the wiring board. To power the sensor using the switch power output (SPx), replace the PWR with SPx in these wiring diagrams.

Discrete Output Wiring (PNP)

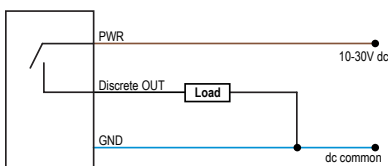

Wiring Diagrams for Analog Inputs

Connecting dc power to the communication pins will cause permanent damage. Do not exceed analog input ratings for analog inputs. Only connect sensor outputs to analog inputs.

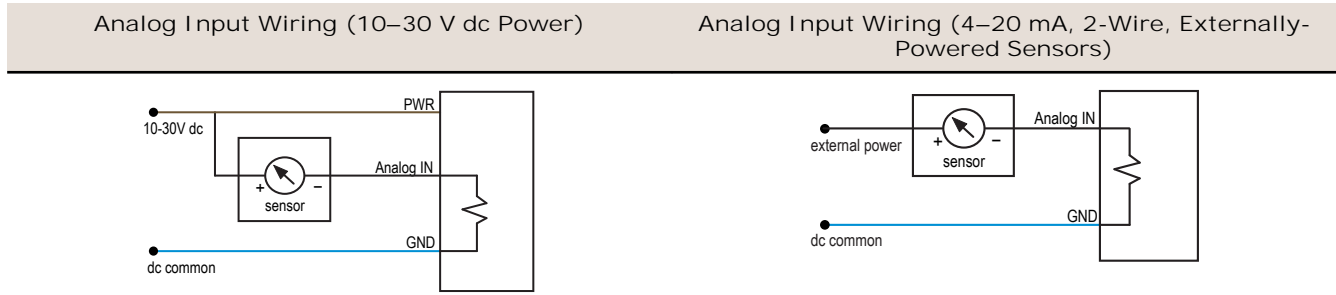

Wiring Diagrams for Analog Outputs

Connecting dc power to the communication pins will cause permanent damage.

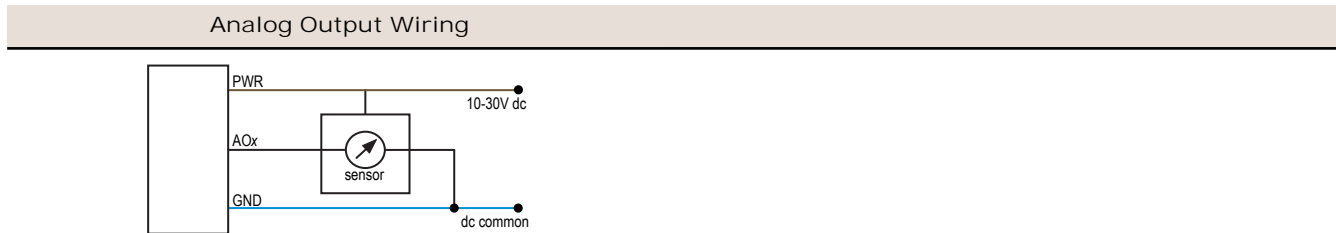

Bind Radios to Form Networks

Binding Nodes to a Gateway ensures the Nodes only exchange data with the Gateway they are bound to.

Apply power to the Gateway and the Node you are binding.

1. To enter binding mode on the Gateway, triple-click button 2.
The red LEDs flash alternately when the Gateway is in binding mode. Any Node entering binding mode will bind to this Gateway.
2. To enter binding mode on the Node, triple-click button 2.

The Node enters binding mode and locates the Gateway in binding mode. The red LEDs flash alternately. The Node automatically exits binding mode. After the Node is bound, the LEDs are both solid red for a few seconds. The Node cycles its power, then enters Run mode.

3. Use both of the Node's rotary dials to assign a the Node Address defined in the Gateway's datasheet. The left rotary dial represents the tens digit (0 through 4) and the right dial represents the ones digit (0 through 9) of the Node Address.
4. Repeat steps 2 and 3 for all Nodes that need to communicate to this Gateway.
5. Exit binding mode on the Gateway by single-clicking either button 1 or button 2.

LED Behavior for the Nodes

Nodes do not sample inputs until they are communicating with the Gateway. The radios and antennas must be a minimum distance apart to function properly. Recommended minimum distances are:

- 2.4 GHz 65 mW radios: 1 foot
- 900 MHz 150 mW radios: 6 feet
- 900 MHz 1 Watt radios: 15 feet

LED 1	LED 2	Node Status
Flashing green		Radio Link Ok
Flashing red	Flashing red	Device Error

LED 1	LED 2	Node Status
	Flashing red, 1 per 3 sec	No Radio Link

Modbus Register Table

I/O	Modbus Holding Register		I/O Type	Units	I/O Range		Holding Register Representation	
	Gateway	Any Node			Min. Value	Max. Value	Min. (Dec.)	Max. (Dec.)
1	1	1 + (Node# × 16)	Discrete IN 1	-	0	1	0	1
2	2	2 + (Node# × 16)	Discrete IN 2	-	0	1	0	1
3	3	3 + (Node# × 16)	Discrete IN 3	-	0	1	0	1
4	4	4 + (Node# × 16)	Discrete IN 4	-	0	1	0	1
5	5	5 + (Node# × 16)	Analog IN 5	mA	0.0	20.0	0	65535
6	6	6 + (Node# × 16)	Analog IN 6	mA	0.0	20.0	0	65535
7	7	7 + (Node# × 16)	Reserved					
8	8	8 + (Node# × 16)	Device Message					
9	9	9 + (Node# × 16)	Discrete OUT 9	-	0	1	0	1
10	10	10 + (Node# × 16)	Discrete OUT 10	-	0	1	0	1
11	11	11 + (Node# × 16)	Discrete OUT 11	-	0	1	0	1
12	12	12 + (Node# × 16)	Discrete OUT 12	-	0	1	0	1
13	13	13 + (Node# × 16)	Analog OUT 13	mA	0.0	20.0	0	65535
14	14	14 + (Node# × 16)	Analog OUT 14	mA	0.0	20.0	0	65535
15	15	15 + (Node# × 16)	Control Message					
16	16	16 + (Node# × 16)	Reserved					

Specifications

Radio Range²

900 MHz, 1 Watt: Up to 9.6 km (6 miles)
2.4 GHz, 65 mW: Up to 3.2 km (2 miles)

Minimum Separation Distance

900 MHz, 1 Watt: 4.57 m (15 ft)
2.4 GHz, 65 mW: 0.3 m (1 ft)

Radio Transmit Power

900 MHz, 1 Watt: 30 dBm (1 W) conducted (up to 36 dBm EIRP)
2.4 GHz, 65 mW: 18 dBm (65 mW) conducted, less than or equal to 20 dBm (100 mW) EIRP

900 MHz Compliance (1 Watt)

FCC ID UE3RM1809: This device complies with FCC Part 15, Subpart C, 15.247
IC: 7044A-RM1809

2.4 GHz Compliance

FCC ID UE300DX80-2400 - This device complies with FCC Part 15, Subpart C, 15.247
ETSI EN 300 328 V1.8.1 (2012-06)
IC: 7044A-DX8024

Spread Spectrum Technology

FHSS (Frequency Hopping Spread Spectrum)

Supply Voltage

10 to 30 V dc (Outside the USA: 12 to 24 V dc, ±10%).³
900 MHz Consumption: Maximum current draw is < 100 mA and typical current draw is < 50 mA at 24 V dc. (2.4 GHz consumption is less.)

Housing

Polycarbonate housing and rotary dial cover; polyester labels; EDPM rubber cover gasket; nitrile rubber, non-sulphur cured button covers
Weight: 0.26 kg (0.57 lbs)
Mounting: #10 or M5 (SS M5 hardware included)
Max. Tightening Torque: 0.56 N-m (5 lbf-in)

Antenna Connection

Ext. Reverse Polarity SMA, 50 Ohms
Max Tightening Torque: 0.45 N-m (4 lbf-in)

Interface

Indicators: Two bi-color LEDs
Buttons: Two
Display: Six character LCD

Wiring Access

Two 1/2-in NPT

Link Timeout

Gateway: Configurable via User Configuration Tool (UCT) software
Node: Defined by Gateway

² Radio range is with the 2 dB antenna that ships with the product. High-gain antennas are available, but the range depends on the environment and line of sight. To determine the range of your wireless network, perform a Site Survey.

³ For European applications, power the DX80 from a Limited Power Source as defined in EN 60950-1.

Operating Conditions⁴

–40 °C to +85 °C (–40 °F to +185 °F) (Electronics); –20 °C to +80 °C (–4 °F to +176 °F) (LCD)
 95% maximum relative humidity (non-condensing)
 Radiated Immunity: 10 V/m (EN 61000-4-3)

Shock and Vibration

IEC 68-2-6 and IEC 68-2-27
 Shock: 30g, 11 millisecond half sine wave, 18 shocks
 Vibration: 0.5 mm p-p, 10 to 60 Hz

Discrete Inputs

Four, DIP switch selectable between PNP and NPN
 Rating: 3 mA max current at 30 V dc
 Sample Rate: 62.5 milliseconds
 Report Rate: On change of state

Discrete Input ON Condition

PNP: Greater than 8 V
 NPN: Less than 0.7 V

Discrete Input OFF Condition

PNP: Less than 5 V
 NPN: Greater than 2 V or open

Analog Inputs

Two, 0 to 20 mA
 Rating: 24 mA
 Impedance: Approx. 220 Ohms
 Sample Rate: 62.5 milliseconds
 Report Rate: 1 second or On Change of State (1% change in value)
 Accuracy: 0.2% of full scale +0.01% per °C
 Resolution: 12-bit

Environmental Ratings⁵

PM2 Model: IEC IP67; NEMA 6
 "C" Housing Models/External wiring terminals: IEC IP20; NEMA 1

Certification**Discrete Outputs**

Four, PNP
 Update Rate: 125 milliseconds
 ON Condition: Supply minus 2 V
 OFF Condition: Less than 2 V
 Output State Following Timeout: OFF

Discrete Output Rating (PNP)

100 mA max current at 30 V dc
 ON-State Saturation: Less than 3 V at 100 mA
 OFF-state Leakage: Less than 10 µA

Analog Outputs

Two, 0 to 20 mA
 Update Rate: 125 milliseconds
 Accuracy: 0.1% of full scale +0.01% per °C
 Resolution: 12-bit

Included with Model

The following items ship with the PM2 and PM8 radios.

- One 1/2-inch NPT plug (not included with IP20 "C" models)
- Two 1/2-inch nylon gland fittings (not included with IP20 "C" models)
- BWA-902-C (900 MHz) or BWA-202-C (2.4 GHz): Antenna, 2 dBd Omni, Rubber Swivel RP-SMA Male. (Not included with Internal antenna models)
- BWA-HW-011: IP20 Screw Terminal Headers (2 pack) (included only with the IP20 "C" models)

Warnings

Antenna Installations. Install and properly ground a qualified surge suppressor when installing a remote antenna system. Remote antenna configurations installed without surge suppressors invalidate the manufacturer's warranty. Keep the ground wire as short as possible and make all ground connections to a single-point ground system to ensure no ground loops are created. No surge suppressor can absorb all lightning strikes; do not touch the Sure Cross® device or any equipment connected to the Sure Cross device during a thunderstorm.

Exporting Sure Cross® Radios. It is our intent to fully comply with all national and regional regulations regarding radio frequency emissions. Customers who want to re-export this product to a country other than that to which it was sold must ensure the device is approved in the destination country. A list of approved countries appears in the *Radio Certifications* section of the product manual. The Sure Cross wireless products were certified for use in these countries using the antenna that ships with the product. When using other antennas, verify you are not exceeding the transmit power levels allowed by local governing agencies. Consult with Banner Engineering Corp. if the destination country is not on this list.

Violating Warnings. The manufacturer does not take responsibility for the violation of any warning listed in this document. Make no modifications to this product; any modifications to this product not expressly approved by Banner Engineering could void the user's authority to operate the product. All specifications published in this document are subject to change; Banner reserves the right to modify product specifications or update documentation at any time. For the most recent version of any documentation, refer to: www.bannerengineering.com. © Banner Engineering Corp. All rights reserved.

⁴ Operating the devices at the maximum operating conditions for extended periods can shorten the life of the device.

⁵ Refer to the *Sure Cross® Wireless I/O Networks Instruction Manual* (p/n 132607) for installation and waterproofing instructions.

Banner Engineering Corp. Limited Warranty

Banner Engineering Corp. warrants its products to be free from defects in material and workmanship for one year following the date of shipment. Banner Engineering Corp. will repair or replace, free of charge, any product of its manufacture which, at the time it is returned to the factory, is found to have been defective during the warranty period. This warranty does not cover damage or liability for misuse, abuse, or the improper application or installation of the Banner product.

THIS LIMITED WARRANTY IS EXCLUSIVE AND IN LIEU OF ALL OTHER WARRANTIES WHETHER EXPRESS OR IMPLIED (INCLUDING, WITHOUT LIMITATION, ANY WARRANTY OF MERCHANTABILITY OR FITNESS FOR A PARTICULAR PURPOSE), AND WHETHER ARISING UNDER COURSE OF PERFORMANCE, COURSE OF DEALING OR TRADE USAGE.

This Warranty is exclusive and limited to repair or, at the discretion of Banner Engineering Corp., replacement. IN NO EVENT SHALL BANNER ENGINEERING CORP. BE LIABLE TO BUYER OR ANY OTHER PERSON OR ENTITY FOR ANY EXTRA COSTS, EXPENSES, LOSSES, LOSS OF PROFITS, OR ANY INCIDENTAL, CONSEQUENTIAL OR SPECIAL DAMAGES RESULTING FROM ANY PRODUCT DEFECT OR FROM THE USE OR INABILITY TO USE THE PRODUCT, WHETHER ARISING IN CONTRACT OR WARRANTY, STATUTE, TORT, STRICT LIABILITY, NEGLIGENCE, OR OTHERWISE.

Banner Engineering Corp. reserves the right to change, modify or improve the design of the product without assuming any obligations or liabilities relating to any product previously manufactured by Banner Engineering Corp.



more sensors, more solutions

www.bannerengineering.com - Tel: +1-763-544-3164