

User Instructions

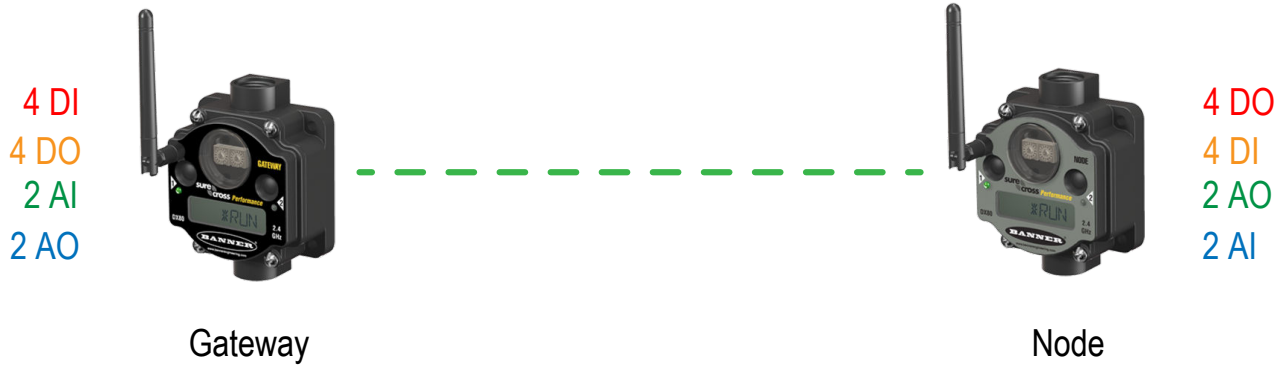

The SureCross® Performance Mapping kits create a radio frequency network with integrated I/O that can operate in most environments and eliminate the need for wiring runs. The Performance Mapping kits include one Gateway, which acts as the wireless network master device, and one Nodes.

Kit	Gateway and Node in Kit	Frequency	Inputs and Outputs
DX80K9M6-PM2	Gateway: DX80G9M6S-PM2 Node: DX80N9X6S-PM2	900 MHz, ISM Band	Inputs: Four selectable discrete, two 0–20 mA Outputs: Four PNP discrete, two 0–20 mA analog
DX80K2M6-PM2	Gateway: DX80G2M6S-PM2 Node: DX80N2X6S-PM2	2.4 GHz, ISM Band	I/O is automatically mapped to the PM2 Gateway using the Gateway's menu system

To view or download the latest technical information about this product, including specifications, dimensions, accessories, and wiring, see <http://www.bannerengineering.com>.



WARNING: Not To Be Used for Personnel Protection

Never use this device as a sensing device for personnel protection. Doing so could lead to serious injury or death. This device does not include the self-checking redundant circuitry necessary to allow its use in personnel safety applications. A sensor failure or malfunction can cause either an energized or de-energized sensor output condition.



CAUTION: Never Operate 1 Watt Radios Without Antennas

To avoid damaging the radio circuitry, never power up Sure Cross® Performance or Sure Cross MultiHop (1 Watt) radios without an antenna.



CAUTION: Electrostatic Discharge (ESD)

ESD Sensitive Device. This product uses semiconductors that can be damaged by electrostatic discharge (ESD). When performing maintenance, care must be taken so the device is not damaged. Disconnect power from the device when accessing the internal DIP switches. Proper handling procedures include wearing anti-static wrist straps. Damage from inappropriate handling is not covered by warranty.



Connecting the Sensors

Gateway and Node Terminals	Terminal Labels
----------------------------	-----------------

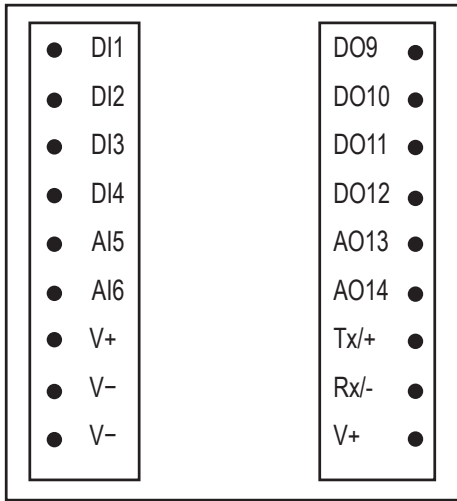

- AIx or Ax. Analog IN x
- AOx. Analog OUT x
- DIx. Discrete IN x
- DOx. Discrete OUT x
- Rx/-. Serial communication line for the Gateway. No connection for Nodes
- Tx/+. Serial communication line for the Gateway; no connection for Nodes
- V+. 10 to 30 V dc power connection
- V-. Ground/dc common connection

Wiring Diagrams for Discrete Inputs

Connecting dc power to the communication pins will cause permanent damage. For the DX8x...C models, PWR in the wiring diagram refers to V+ on the wiring board and GND in the wiring diagram refers to V- on the wiring board. To power the sensor using the switch power output (SPx), replace the PWR with SPx in these wiring diagrams.

Discrete Input Wiring for PNP Sensors	Discrete Input Wiring for NPN Sensors
---------------------------------------	---------------------------------------

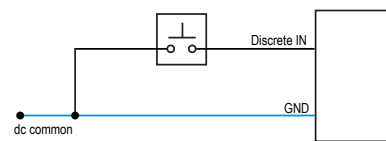
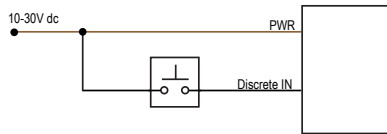

Wiring Diagrams for Discrete Outputs

Connecting dc power to the communication pins will cause permanent damage. For the DX8x...C models, PWR in the wiring diagram refers to V+ on the wiring board and GND in the wiring diagram refers to V- on the wiring board. To power the sensor using the switch power output (SPx), replace the PWR with SPx in these wiring diagrams.

Discrete Output Wiring (PNP)

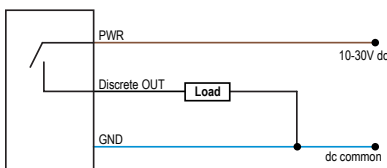

Wiring Diagrams for Analog Inputs

Connecting dc power to the communication pins will cause permanent damage. Do not exceed analog input ratings for analog inputs. Only connect sensor outputs to analog inputs.

Analog Input Wiring (10–30 V dc Power)

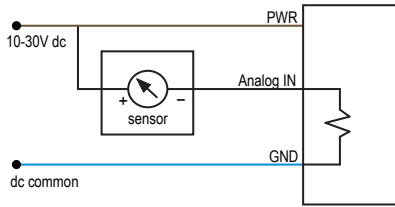

Analog Input Wiring (4–20 mA, 2-Wire, Externally-Powered Sensors)

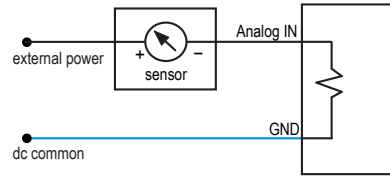

Wiring Diagrams for Analog Outputs

Connecting dc power to the communication pins will cause permanent damage.

Analog Output Wiring

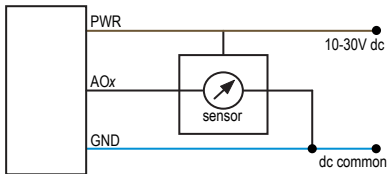

LED Behavior for the PMx Kits

Verify all devices are communicating properly. The radios and antennas must be a minimum distance apart to function properly. Recommended minimum distances are:

- 900 MHz 1 Watt radios: 15 feet
- 2.4 GHz 65 mW radios: 1 foot

Gateway LEDs

LED 1	LED 2	Gateway Status
Solid green		Power ON
Flashing red	Flashing red	Device Error
	Flashing amber	Modbus Communication Active
	Flashing red	Modbus Communication Error

The Modbus communication LEDs refer to the communication between the Gateway and its host system (if applicable).

Node LEDs

LED 1	LED 2	Node Status
Flashing green		Radio Link Ok
Flashing red	Flashing red	Device Error
	Flashing red, 1 per 3 sec	No Radio Link

I/O Mapping for the PM2 Kits

Gateway	Maps to	Node
Discrete IN 1	→	Discrete OUT 9
Discrete IN 2	→	Discrete OUT 10
Discrete IN 3	→	Discrete OUT 11
Discrete IN 4	→	Discrete OUT 12
Analog IN 5	→	Analog OUT 13
Analog IN 6	→	Analog OUT 14
Discrete OUT 9	←	Discrete IN 1
Discrete OUT 10	←	Discrete IN 2
Discrete OUT 11	←	Discrete IN 3
Discrete OUT 12	←	Discrete IN 4
Analog OUT 13	←	Analog IN 5
Analog OUT 14	←	Analog IN 6

To add additional Nodes to your original kit, download the Performance PM2 Gateway datasheet (p/n [173566](#)) for the I/O mapping options.

Modbus Register Table

I/O	Modbus Holding Register		I/O Type	Units	I/O Range		Holding Register Representation	
	Gateway	Any Node			Min. Value	Max. Value	Min. (Dec.)	Max. (Dec.)
1	1	1 + (Node# × 16)	Discrete IN 1	-	0	1	0	1
2	2	2 + (Node# × 16)	Discrete IN 2	-	0	1	0	1
3	3	3 + (Node# × 16)	Discrete IN 3	-	0	1	0	1
4	4	4 + (Node# × 16)	Discrete IN 4	-	0	1	0	1
5	5	5 + (Node# × 16)	Analog IN 5	mA	0.0	20.0	0	65535
6	6	6 + (Node# × 16)	Analog IN 6	mA	0.0	20.0	0	65535
7	7	7 + (Node# × 16)	Reserved					
8	8	8 + (Node# × 16)	Device Message					
9	9	9 + (Node# × 16)	Discrete OUT 9	-	0	1	0	1
10	10	10 + (Node# × 16)	Discrete OUT 10	-	0	1	0	1
11	11	11 + (Node# × 16)	Discrete OUT 11	-	0	1	0	1
12	12	12 + (Node# × 16)	Discrete OUT 12	-	0	1	0	1
13	13	13 + (Node# × 16)	Analog OUT 13	mA	0.0	20.0	0	65535
14	14	14 + (Node# × 16)	Analog OUT 14	mA	0.0	20.0	0	65535
15	15	15 + (Node# × 16)	Control Message					
16	16	16 + (Node# × 16)	Reserved					

Specifications

Radio Range

- 900 MHz, 1 Watt: Up to 9.6 km (6 miles) ¹
- 2.4 GHz, 65 mW: Up to 3.2 km (2 miles)

Minimum Separation Distance

- 900 MHz, 1 Watt: 4.57 m (15 ft)
- 2.4 GHz, 65 mW: 0.3 m (1 ft)

Radio Transmit Power

- 900 MHz, 1 Watt: 30 dBm (1 W) conducted (up to 36 dBm EIRP)
- 2.4 GHz, 65 mW: 18 dBm (65 mW) conducted, less than or equal to 20 dBm (100 mW) EIRP

900 MHz Compliance (1 Watt)

- FCC ID UE3RM1809: This device complies with FCC Part 15, Subpart C, 15.247
- IC: 7044A-RM1809

2.4 GHz Compliance

- FCC ID UE300DX80-2400 - This device complies with FCC Part 15, Subpart C, 15.247
- ETSI EN 300 328 V1.8.1 (2012-06)
- IC: 7044A-DX8024

Spread Spectrum Technology

- FHSS (Frequency Hopping Spread Spectrum)

Notes

Notice: This equipment must be professionally installed. The output power must be limited, through the use of firmware or a hardware attenuator, when using high-gain antennas such that the +36 dBm EIRP limit is not exceeded.

Supply Voltage

- 10 to 30 V dc (Outside the USA: 12 to 24 V dc, ±10%). ²

Power Consumption

- 900 MHz Consumption: Maximum current draw is < 100 mA and typical current draw is < 50 mA at 24 V dc. (2.4 GHz consumption is less.)

Housing

- Polycarbonate housing and rotary dial cover; polyester labels; EDPM rubber cover gasket; nitrile rubber, non-sulphur cured button covers
- Weight: 0.26 kg (0.57 lbs)
- Mounting: #10 or M5 (SS M5 hardware included)
- Max. Tightening Torque: 0.56 N-m (5 lbf-in)

Antenna Connection

- Ext. Reverse Polarity SMA, 50 Ohms
- Max Tightening Torque: 0.45 N-m (4 lbf-in)

Interface

- Indicators: Two bi-color LEDs
- Buttons: Two
- Display: Six character LCD

Wiring Access

- Two 1/2-inch NPT ports

Environmental Ratings

- IEC IP67; NEMA 6 ³

Operating Conditions

- 40 °C to +85 °C (-40 °F to +185 °F) (Electronics); -20 °C to +80 °C (-4 °F to +176 °F) (LCD) ⁴
- 95% maximum relative humidity (non-condensing)
- Radiated Immunity:

Shock and Vibration

- IEC 68-2-6 and IEC 68-2-27
- Shock: 30g, 11 millisecond half sine wave, 18 shocks
- Vibration: 0.5 mm p-p, 10 to 60 Hz

Certifications



Inputs

Discrete Inputs

- Four, DIP switch selectable between sourcing/PNP and sinking/NPN
- Rating: 3 mA max current at 30 V dc
- Sample Rate: 62.5 milliseconds
- Report Rate: On change of state

Discrete Input ON Condition

- PNP: Greater than 8 V
- NPN: Less than 0.7 V

Discrete Input OFF Condition

- PNP: Less than 5 V
- NPN: Greater than 2 V or open

Analog Inputs

- Two, 0 to 20mA
- Rating: 24 mA
- Impedance: Approx. 220 Ohms
- Sample Rate: 62.5 milliseconds
- Report Rate: 1 second or On Change of State (1% change in value)
- Accuracy: 0.2% of full scale +0.01% per °C
- Resolution: 12-bit

Outputs

Discrete Outputs

- Four, Sourcing/PNP
- Update Rate: 125 milliseconds
- ON Condition: Supply minus 2 V
- OFF Condition: Less than 2 V
- Output State Following Timeout: OFF

Discrete Output Rating (PNP)

- 100 mA max current at 30 V dc
- ON-State Saturation: Less than 3 V at 100 mA
- OFF-state Leakage: Less than 10 µA

Analog Outputs

- Two, 0 to 20 mA
- Update Rate: 125 milliseconds
- Accuracy: 0.1% of full scale +0.01% per °C
- Resolution: 12-bit

Communication (Gateway only)

Communication Hardware (RS-485)

- Interface: 2-wire half-duplex RS-485
- Baud rates: 9.6k, 19.2k (default), or 38.4k
- Data format: 8 data bits, no parity, 1 stop bit

Communication Protocol

- Modbus RTU

¹ Radio range is with the 2 dB antenna that ships with the product. High-gain antennas are available, but the range depends on the environment and line of sight. To determine the range of your wireless network, perform a Site Survey.

² For European applications, power the DX80 from a Limited Power Source as defined in EN 60950-1.

³ Refer to the [Sure Cross® Wireless I/O Networks Instruction Manual](#) (p/n 132607) for installation and waterproofing instructions.

⁴ Operating the devices at the maximum operating conditions for extended periods can shorten the life of the device.

Warnings

Antenna Installations. Install and properly ground a qualified surge suppressor when installing a remote antenna system. Remote antenna configurations installed without surge suppressors invalidate the manufacturer's warranty. Keep the ground wire as short as possible and make all ground connections to a single-point ground system to ensure no ground loops are created. No surge suppressor can absorb all lightning strikes; do not touch the Sure Cross® device or any equipment connected to the Sure Cross device during a thunderstorm.

Exporting Sure Cross® Radios. It is our intent to fully comply with all national and regional regulations regarding radio frequency emissions. Customers who want to re-export this product to a country other than that to which it was sold must ensure the device is approved in the destination country. A list of approved countries appears in the *Radio Certifications* section of the product manual. The Sure Cross wireless products were certified for use in these countries using the antenna that ships with the product. When using other antennas, verify you are not exceeding the transmit power levels allowed by local governing agencies. Consult with Banner Engineering Corp. if the destination country is not on this list.

Violating Warnings. The manufacturer does not take responsibility for the violation of any warning listed in this document. Make no modifications to this product; any modifications to this product not expressly approved by Banner Engineering could void the user's authority to operate the product. All specifications published in this document are subject to change; Banner reserves the right to modify product specifications or update documentation at any time. For the most recent version of any documentation, refer to: www.bannerengineering.com. © Banner Engineering Corp. All rights reserved.

Banner Engineering Corp. Limited Warranty

Banner Engineering Corp. warrants its products to be free from defects in material and workmanship for one year following the date of shipment. Banner Engineering Corp. will repair or replace, free of charge, any product of its manufacture which, at the time it is returned to the factory, is found to have been defective during the warranty period. This warranty does not cover damage or liability for misuse, abuse, or the improper application or installation of the Banner product.

THIS LIMITED WARRANTY IS EXCLUSIVE AND IN LIEU OF ALL OTHER WARRANTIES WHETHER EXPRESS OR IMPLIED (INCLUDING, WITHOUT LIMITATION, ANY WARRANTY OF MERCHANTABILITY OR FITNESS FOR A PARTICULAR PURPOSE), AND WHETHER ARISING UNDER COURSE OF PERFORMANCE, COURSE OF DEALING OR TRADE USAGE.

This Warranty is exclusive and limited to repair or, at the discretion of Banner Engineering Corp., replacement. IN NO EVENT SHALL BANNER ENGINEERING CORP. BE LIABLE TO BUYER OR ANY OTHER PERSON OR ENTITY FOR ANY EXTRA COSTS, EXPENSES, LOSSES, LOSS OF PROFITS, OR ANY INCIDENTAL, CONSEQUENTIAL OR SPECIAL DAMAGES RESULTING FROM ANY PRODUCT DEFECT OR FROM THE USE OR INABILITY TO USE THE PRODUCT, WHETHER ARISING IN CONTRACT OR WARRANTY, STATUTE, TORT, STRICT LIABILITY, NEGLIGENCE, OR OTHERWISE.

Banner Engineering Corp. reserves the right to change, modify or improve the design of the product without assuming any obligations or liabilities relating to any product previously manufactured by Banner Engineering Corp.