

# FLEX-PRO<sup>®</sup>

Peristaltic Metering Pump



## SERIES A2F

Operating Manual

Exclusive:



# ProSeries<sup>®</sup>

by Blue-White Ind.

Protected by Patents: 8,418,364; 8,215,931;  
7,001,153; 7,284,964; 4,496,295  
and other patents pending

5300 Business Drive, Huntington Beach, CA 92649 USA

Phone: 714-893-8529 FAX: 714-894-9492

E mail: sales@blue-white.com | techsupport@blue-white.com URL: www.Blue-White.com

## TABLE OF CONTENTS

<u>Section</u>	<u>Heading</u>	<u>Page</u>
1.0	Introduction . . . . .	3
1.1	Available Models . . . . .	3
2.0	Specifications . . . . .	4
2.1	Materials of Construction . . . . .	4
3.0	Features . . . . .	5
3.1	Agency Listings . . . . .	5
4.0	Installation. . . . .	6
4.1	Mounting Location . . . . .	6
4.2	Dimensions . . . . .	6
4.3	Installing Injection Fitting and Strainer . . . . .	7
5.0	Power Connections . . . . .	8
5.1	Wiring Terminal and I/O Schematics . . . . .	9
6.0	How to Operate Flex-Pro - Control Pad . . . . .	10
7.0	Set Remote Start / Stop . . . . .	11
7.1	Set FVS (flow verification system) . . . . .	12, 13
8.0	Manual Operation . . . . .	14
9.0	Pump Tube Timer . . . . .	15
10.0	TFD (Tube Failure Detection) . . . . .	15
11.0	Alarm Relay . . . . .	16
12.0	Reverse Rotation . . . . .	16
13.0	Tube Replacement. . . . .	17
13.1	Tube Removal . . . . .	17
13.2	Tube Installation. . . . .	18
14.0	Pump Maintenance . . . . .	19
15.0	Pump Head Replacement Parts List . . . . .	20
16.0	Output Versus Fluid Viscosity . . . . .	21
	Warranty . . . . .	22

PLEASE READ ENTIRE INSTRUCTION MANUAL PRIOR TO INSTALLATION AND USE.

## 1.0 Introduction

Congratulations on purchasing Flex-Pro variable speed Peristaltic Metering Pump. A peristaltic pump is a type of positive displacement pump used for pumping a variety of fluids.

Your Flex-Pro pump is pre-configured for tubing that shipped with your metering pump. Tubing assembly has an Identification number printed on tube for easy re-order; such as ND, NH, etc.

**Please Note:** Your new pump has been pressure tested at the factory with clean water before shipping. You may notice trace amounts of clean water in pre-installed tube assembly. This is part of our stringent quality assurance program at Blue-White Industries.

## 1.1 Available Models

Feed Rate			Max Speed	Max Pressure	Max Temperature	A2 Model Numbers		
<b>Norprene® A2 Tube Pumps</b>								
Meets FDA criteria for food   Excellent chemical resistance   CIP   SIP								
GPH	LPH	ML/Min	RPM	PSI (bar)	F (C)	115V AC	230V AC	220V AC
.02 - 1.7	.07 - 6.5	1 - 108	130	125 (8.6)	185 (85)	A2F24-*ND	A2F25-*ND	A2F26-*ND
<b>Flex-A-Prene® A2 Tube Pumps</b>								
Meets FDA criteria for food   Excellent chemical resistance   Extra long tube life								
GPH	LPH	ML/Min	RPM	PSI (bar)	F (C)	115V AC	230V AC	220V AC
.05 - 4.5	.17 - 16.9	2.8 - 280	130	110 (7.6)	185 (85)	A2F24-*NEE	A2F25-*NEE	A2F26-*NEE
.17 - 17.2	.65 - 65.1	10.9 - 1085	130	110 (7.6)	185 (85)	A2F24-*NGG	A2F25-*NGG	A2F26-*NGG
<b>Norprene® Chemical A2 Tube Pumps</b>								
Meets FDA criteria for food   Superb chemical resistance								
GPH	LPH	ML/Min	RPM	PSI (bar)	F (C)	115V AC	230V AC	220V AC
.15 - 14.9	.56 - 56.2	9 - 937	130	50 (3.4)	130 (54)	A2F24-*TH	A2F25-*TH	A2F26-*TH
<b>Tygothane® A2 Tube Pumps</b>								
Meets FDA criteria for food   Resistant to oils, greases and fuels								
GPH	LPH	ML/Min	RPM	PSI (bar)	F (C)	115V AC	230V AC	220V AC
.04 - 4.0	.15 - 15.2	3 - 253	130	65 (4.5)	130 (54)	A2F24-*GE	A2F25-*GE	A2F26-*GE
.09 - 9.3	.35 - 35.2	6 - 587	130	65 (4.5)	130 (54)	A2F24-*GG	A2F25-*GG	A2F26-*GG
<p>* Inlet/outlet connection type            S = 3/8" OD x 1/4" ID tubing compressions type connections            M = 1/2" male NPT            B = 1/2" Hose barb, Natural PVDF (Kynar), (Flex-A-Prene® model only)            C = 1/2" - 3/4" tri-clamp connections            Q = Quick Disconnect (Flex-A-Prene® model only)</p> <ul style="list-style-type: none"> <li>Flex-Pro Pumps motor speed is linear over entire 1% to 100% adjustment range.</li> <li>Output versus pressure is nearly linear in all models. Larger tubes exhibit greater losses.</li> <li>For optimum tube life, specify pump to operate at lowest possible RPM and pressure.</li> <li>Feed rates taken in laboratory environment with clean water after 20 minute tube break-in period with a 3 foot (1 meter) suction lift.</li> </ul>								

## Optional Extended Brackets

Stainless Steel extended brackets allow pump to be securely mounted to most any surface; floor, shelf, or skid. Brackets lift pump up 4-1/2 inches (11.43 cm), for easy pump access in hard to reach areas.

- Raise metering pump 4-1/2 inches (11.43 cm) off ground or a surface.
- Made out of tough Stainless Steel.
- Provides a stable mounting surface.

Model #	Description
72000-380	Extended Mounting Bracket, 1 Pair, SS, 4 SS Screws



## 2.0 Specifications

### Maximum working pressure (excluding pump tubes):

125 psig (8.6 bar)

Note: see individual pump tube assembly maximum pressure ratings.

### Maximum Fluid temperature (excluding pump tubes):

3/8" OD x 1/4" ID tubing connections: 130° F (54° C)

M/NPT connections: 185° F (85° C)

Note: see individual pump tube assembly maximum temperature ratings.

### Maximum fluid viscosity:

12,000 Centipoise

### Maximum suction lift:

30 ft. Water, 0 psig (4.5 m, 0 bar)

### Ambient Operating Temperature

14°F to 115°F (-10°C to 46°C)

### Ambient Storage Temperature

-40°F to 158°F (-40°C to 70°C)

### Operating Voltage:

115VAC/60Hz, 1ph (1.5 Amp Maximum)

230VAC/60Hz, 1ph (0.7 Amp Maximum)

220VAC/50Hz, 1ph (1.0 Amp Maximum)

240VAC/50Hz, 1ph (1.0 Amp Maximum)

### Power Cord Options:

115V60Hz = NEMA 5/15 (USA)

230V60Hz = NEMA 6/15 (USA)

220V50Hz = CEE 7/II (EU)

240V50Hz = AS 3112 (Australia/New Zealand)

### Motor:

Brushed DC, 1/8 H.P.

### Duty cycle:

Continuous

### Motor speed adjustment range 100:1:

1.0% - 100% motor speed (1.3 to 130 RPM)

### Motor speed adjustment resolution:

0.1% increments

### Display

Backlit LCD, UV resistant.

### Keypad

Eight button positive action tactile switch keypad.

### Enclosure:

NEMA 4X (IP66), Polyester powder coated aluminum.

Maximum Overall Dimensions:

7-1/2" W x 10-1/4" H x 14" D (19 W x 26 H x 35.6 D cm)

### Approximate shipping wt:

25 lb. (12.0 Kg)

## 2.1 Materials of construction

### Wetted components:

#### Pump Tube Assembly (Model Specific - 2 provided):

**Tubing:** . . . . . Norprene® or Norprene Chemical® or Tygothane®

**Adapter fittings:** .PVDF

#### Injection / Back-flow Check valve:

**Body & insert:** . . . . .PVDF

**Check Ball:** . . . . .Ceramic

**Spring:** . . . . .Hastelloy C-276

**Ball Seat O-ring:** . . . . .Viton® (optional EPDM)

**Static Seal O-ring:** . . . . .Viton® (optional EPDM)

**Duckbill anti-scale valve:** Santoprene®

#### Ancillary Items provided

##### With "S" tubing type connections only:

**Suction Tubing:** . . . . . 3/8" OD x 1/4" ID x 10' Clear PVC

**Discharge Tubing:** . . . . . 3/8" OD x 1/4" ID x 10' Polyethylene (LLDPE)

**Suction Strainer:** . . . . . Polypropylene

##### Suction Strainer:

**Body:** . . . . . PVDF

**Check Ball:** . . . . . Ceramic

**Ball Seat O-ring:** . . . . . Viton® (optional EPDM)

##### With "B" tubing and "M" M/NPT connections only:

##### Suction Strainer:

**Body:** . . . . . PVDF

**Check Ball:** . . . . . Ceramic

**Ball Seat O-ring:** . . . . . Viton® (optional EPDM)

##### For "C" Tri-clamp and "Q" Quick Disconnect connections only:

(Available for Flex-A-Prene® only)

**Suction Strainer:** . . . . . Polypropylene

### Non-Wetted components:

#### Enclosure:

413 Aluminum (Polyester powder coated)

#### Pump Head:

Valox® (PBT) thermoplastic

#### Pump Head Cover:

Polycarbonate for added strength and chemical resistance.

Permanently lubricated sealed motor shaft support ball bearing.

#### Cover Screws:

Stainless Steel

#### Roller Assembly:

**Rotor:** . . . . . Valox® (PBT)

**Rollers:** . . . . . Nylon

**Roller Bearings:** . . . . . SS Ball Bearings

#### Motor Shaft:

Chrome plated steel

#### TFD System Sensor pins:

Hastelloy C-276

#### Power Cord:

3 conductor, SJTW-A Water-resistant

#### Tube Installation Tool:

GF Nylon

#### Mounting Brackets and Hardware:

316 Stainless Steel

### 3.0 Features

Peristaltic pump design does not have valves that can clog requiring maintenance.

Self priming - even against maximum line pressure. By-pass valves are not required. Cannot vapor lock or lose prime.

Variable speed DC motor.

Rated for continuous duty (24X7).

Specially engineered tubing for long life at high pressures. Meets FDA 21 CFR requirements for food contact applications.

Patented Tube Failure Detection (TFD) system. Senses tube failure by detecting chemical in pump head.

Backlit LCD displays motor speed, input signal values, service and alarm status.

CNC precision machined squeeze rollers and CNC machined alignment rollers for optimum squeeze, unparalleled accuracy, and tube life.

Heavy duty rotor - single piece plastic rotor means no flexing and increased accuracy with no metal springs or hinges to corrode.

Inject at maximum pressure in either direction (clockwise and counter clockwise).

Compatible with Blue-White's output Flow Verification Sensor (FVS) system.

### 3.1 Agency Listings



This pump is ETL listed to conform to the following:  
UL Standard 778 as a motor operated water pump  
CSA Standard C22.2 as process control equipment



This pump complies to the Machinery Directive 98/37/EC, BS EN 60204-1, Low Voltage Directive 73/23/EC BS EN 61010-1, EMC Directive 89/336/EC, BS EN 50081-1/BS EN 50082-1.

Symbol	Explanation
	WARNING, risk of electric shock
	CAUTION, refer to users' guide
	GROUND, PROTECTIVE CONDUCTOR TERMINAL

#### Enclosure Rating:

**NEMA 4X:** Constructed for either indoor or outdoor use to provide a degree of protection to personnel against incidental contact with enclosed equipment; to provide a degree of protection against falling dirt, rain, sleet, snow, windblown dust, splashing water, and hose-directed water; and that will be undamaged by external formation of ice on enclosure.

**IP66:** No ingress of dust; complete protection against contact. Water projected in powerful jets against enclosure from any direction shall have no harmful effects.

## 4.0 Installation

### CAUTION



Risk of chemical overdose. Be certain pump does not overdose chemical during backwash and periods of no flow in circulation system.

### CAUTION



Always wear protective clothing, face shield, safety glasses and gloves when working on or near your metering pump. Additional precautions should be taken depending on solution being pumped. Refer to MSDS precautions from your solution supplier.

### CAUTION



All diagrams are strictly for guideline purposes only. Always consult an expert before installing metering pump on specialized systems. Metering pump should be serviced by qualified persons only.

## 4.1 Mounting Location

Choose an area located near chemical supply tank, chemical injection point, and electrical supply. Install pump where it can be easily serviced.

316SS Mounting brackets are included. Mount pump to a secure surface using enclosed mounting hardware.

Mount pump close to injection point. Keep inlet (suction) and outlet (discharge) tubing as short as possible. Longer discharge tubing increases back pressure at pump head.

**Important!** Install a back flow prevention check valve at discharge side of pump to prevent system fluid from flowing back through pump during tube replacement or if tube should rupture. **Important!**

A pressure relief valve is recommended at discharge of pump to prevent premature wear and damage to pump tube in event discharge line becomes blocked.

The Flex-Pro does not require back pressure. Keep the discharge pressure as low as possible to maximize tube life.

## 4.2 Dimensions

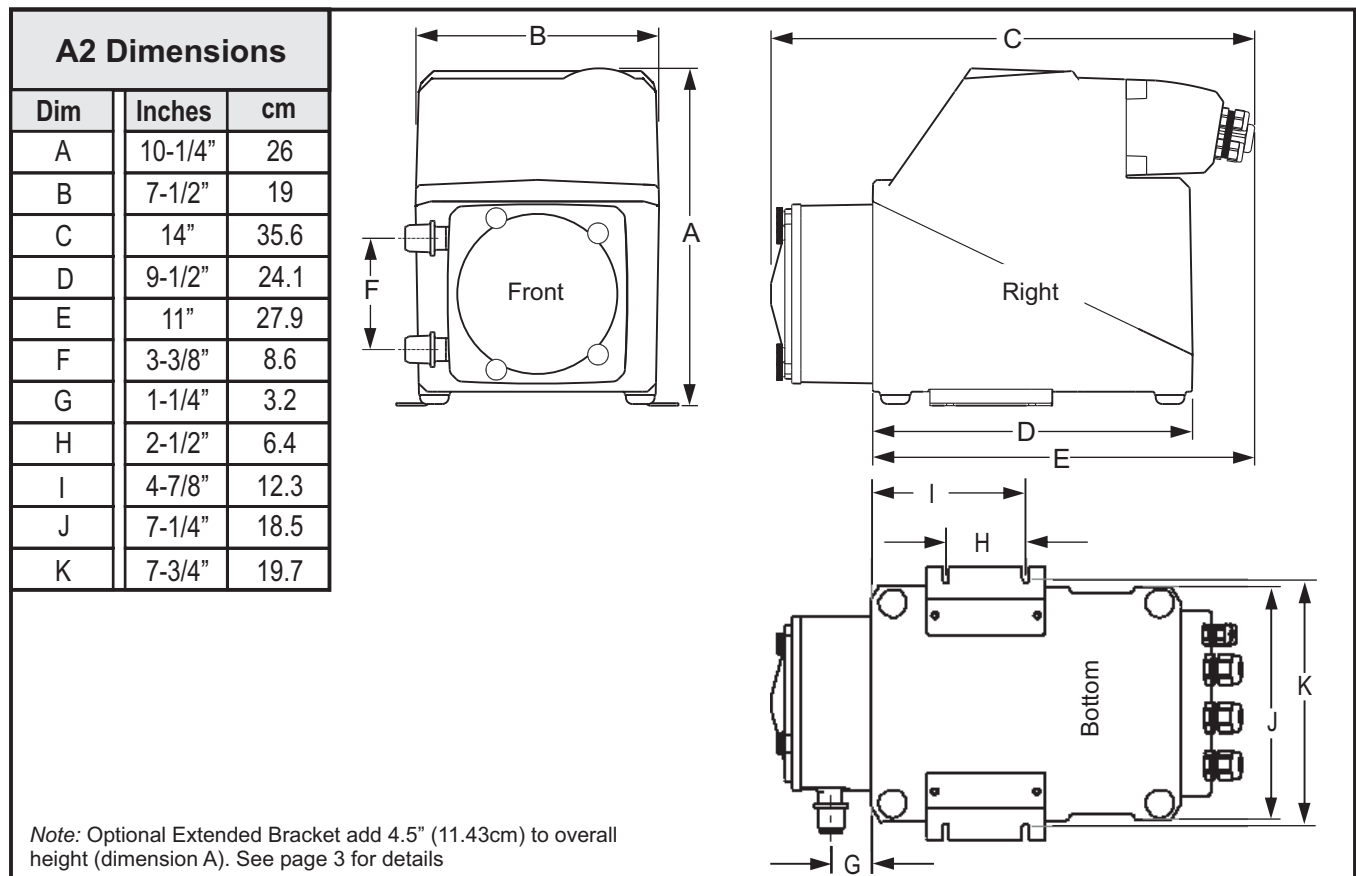



### 4.3 Installing Injection Fitting and Strainer

**CAUTION** Proper eye and skin protection must be worn when installing and servicing pump.

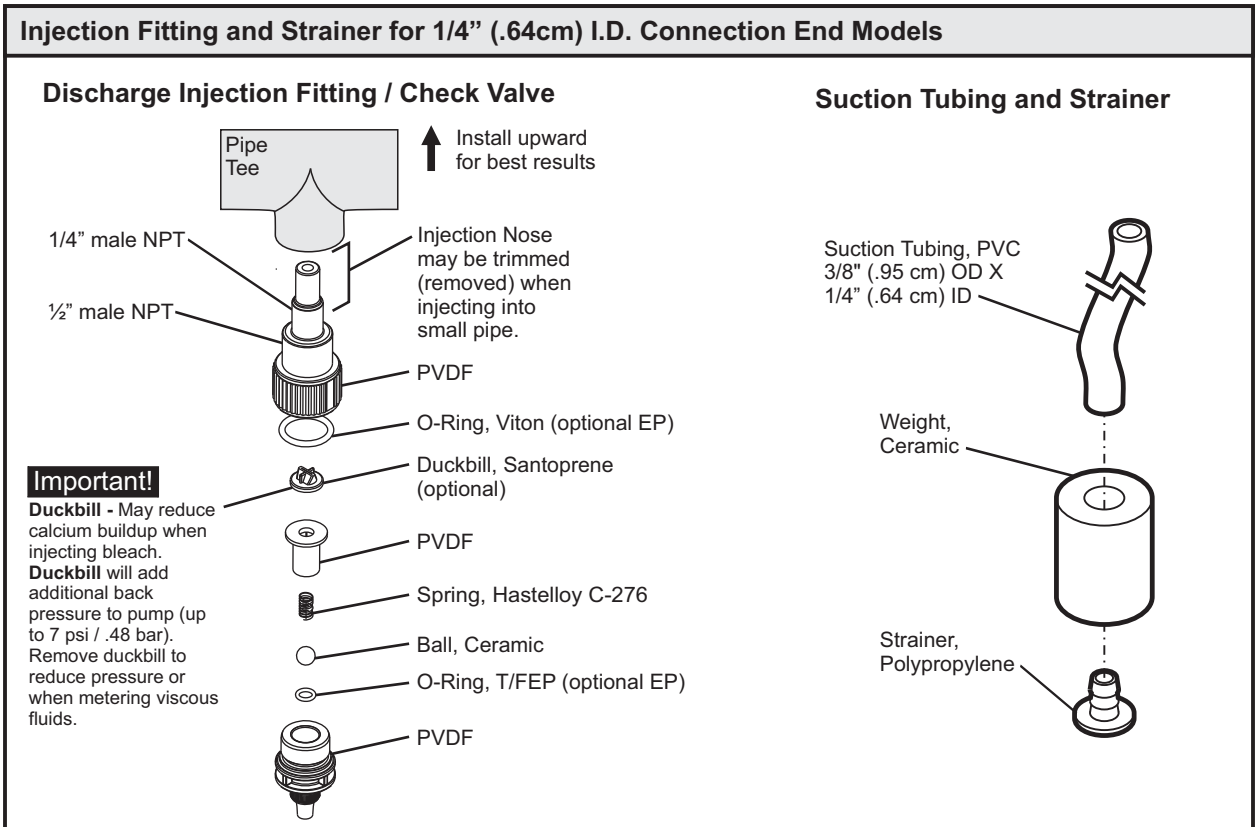
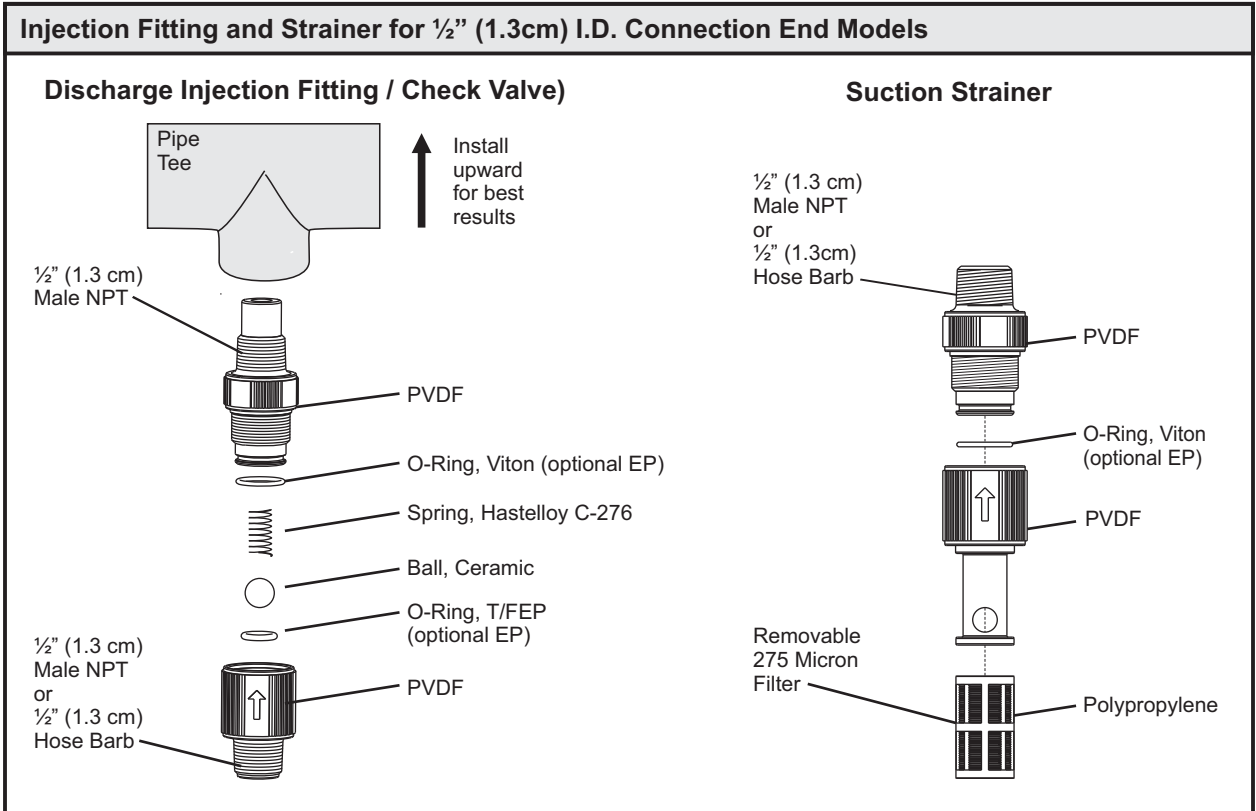
**CAUTION** This Pump Has Been Evaluated for Use with Water Only.



## 5.0 Power Connections

<b>WARNING</b> 	Risk of electric shock – cord connected models are supplied with a grounding conductor and grounding-type attachment plug. To reduce risk of electric shock, be certain that it is connected only to a properly grounded, grounding-type receptacle.
<b>WARNING</b> 	Electrical connections and grounding (earthing) must conform to local wiring codes. Be certain that a grounding conductor is connected to terminal T11-1 located in wiring compartment.
<b>WARNING</b> 	Risk of electric shock - Disconnect electricity before removing wiring compartment cover.

Be certain to connect pump to proper supply voltage. Using incorrect voltage will damage pump and may result in injury. Voltage requirement is printed on pump serial label.

Input power: 115VAC 50/60 Hz 1.5 amp or 230/240VAC 50/60 Hz 0.7 amp.

Power switch located in Junction Box.

Use voltage your power cord is rated for.

Cord connected models are supplied with a ground wire conductor and a grounding type attachment plug (power cord). To reduce risk of electric shock, be certain that power cord is connected only to a properly grounded, grounding type receptacle.

Permanently connected models must be properly grounded. Be certain that a grounding conductor is connected to terminal T11-1 located in wiring compartment.

Never strap control (input / output) cables and power cables together.

**Power Interruption:** This pump has an auto-restart feature which will restore pump to operating state it was in when power was lost.

**Note:** When in doubt regarding your electrical installation, contact a licensed electrician.

### WIRING COMPARTMENT COVER

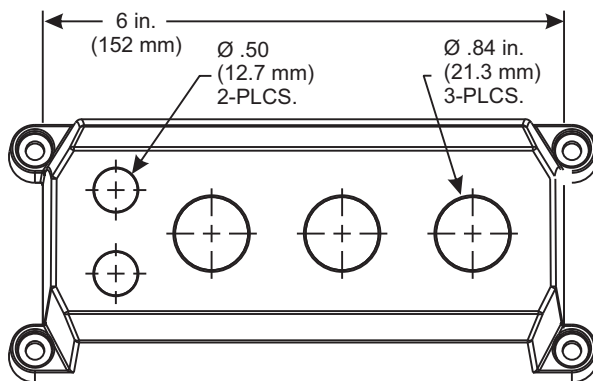

### POWER CORD OPTIONS

Three power cord plug types available. Power cord length is 6 feet (3.83 meters)



115V 60Hz  
NEMA 5/15 (USA)  
max: 125V AC

230V 60Hz  
NEMA 6/15 (USA)  
max: 250V AC

240V 50Hz  
CEE 7/VII (EU)  
max: 250V AC

### Included cable and conduit connectors:

QTY.	DESCRIPTION
Qty: 2	- .50 Inch (12.7 Mm) Liq-tight Hole Plugs (mat'l = Neoprene), Pre-installed
Qty: 2	- .875 Inch (22.2 Mm) Liq-tight Hole Plugs (mat'l = Neoprene), 2 Pre-installed
Qty: 2	- .50 Inch (12.7 Mm) Liq-tight Connectors For Pass Thru Cords (mat'l = Nylon) Acceptable Cable Diameter .118 To .255 Inch (3.0 To 6.5 Mm), Not Installed
Qty: 2	- .875 Inch (22.2 Mm) Liq-tight Connectors For Pass Thru Cords (mat'l = Nylon) Acceptable Cable Diameter .200 To .395 Inch (5.1 To =10.0 Mm), 1 Pre-installed With Power Cord Models
Qty: 1	- Metallic Liq-tight Connectors For .50 Inch Flexible Conduit (mat'l = Die Cast Zinc), Not Installed



### 5.1 Wiring Terminals and I/O Schematics

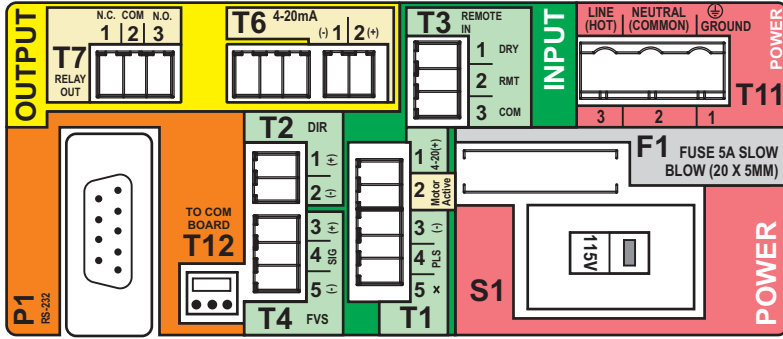

**WARNING** Risk of electric shock - All wiring must be insulated and rated 300V minimum.

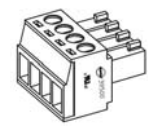

Terminals T1 Thru T8 Plug type 16 - 24 AWG

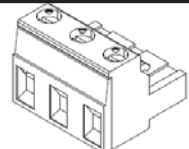

Power Input Terminal T11 Plug type 14 - 30 AWG

Shielded cables should be used on all input signal wires.

FUNCTION	TERM	PIN #	RATING	ELECTRICAL SP.	BLOCK DIAGRAM
INPUT: FVS SYSTEM (FLOW VERIFICATION SENSOR) FV SENSOR ONLY	T4	3	(+) POSITIVE		
	T4	4	SIGNAL		
	T4	5	(-) NEGATIVE		
INPUT: FVS SYSTEM (FLOW VERIFICATION SENSOR) FS or FP MICRO-FLO FLOW METER ONLY	T4	4	SIGNAL		
	T4	5	(-) NEGATIVE		
	T4	5	(-) NEGATIVE		
INPUT: REMOTE START / STOP (DRY CONTACT C.)	T3	1	(+) POSITIVE	NO VOLTAGE	
	T3	2	(-) NEGATIVE		
INPUT: REMOTE START / STOP (WET CONTACT C.)	T3	2	(+) POSITIVE	6 TO 30 VOLT DC 1 AMP MAX.	
	T3	3	(-) NEGATIVE		
OUTPUT: RELAY, 3 AMP	T7	1	NORM. CLOSED	Form C 3 AMP MAX AT 250 VAC, 3 AMP MAX AT 30 VOLT DC	
	T7	2	COMMON		
	T7	3	NORM. OPEN		
INPUT: POWER	T11	1	GROUND	115V OR 230V AC MANUAL SWITCH 50 / 60 HZ 100W	
	T11	2	NEUTRAL		
	T11	3	LINE (HOT)		
FUSE	F1	N/A	5 AMP	5A SLOW BLOW (20 X 5MM)	

## 6.0 How to Operate Flex-Pro - Control Pad

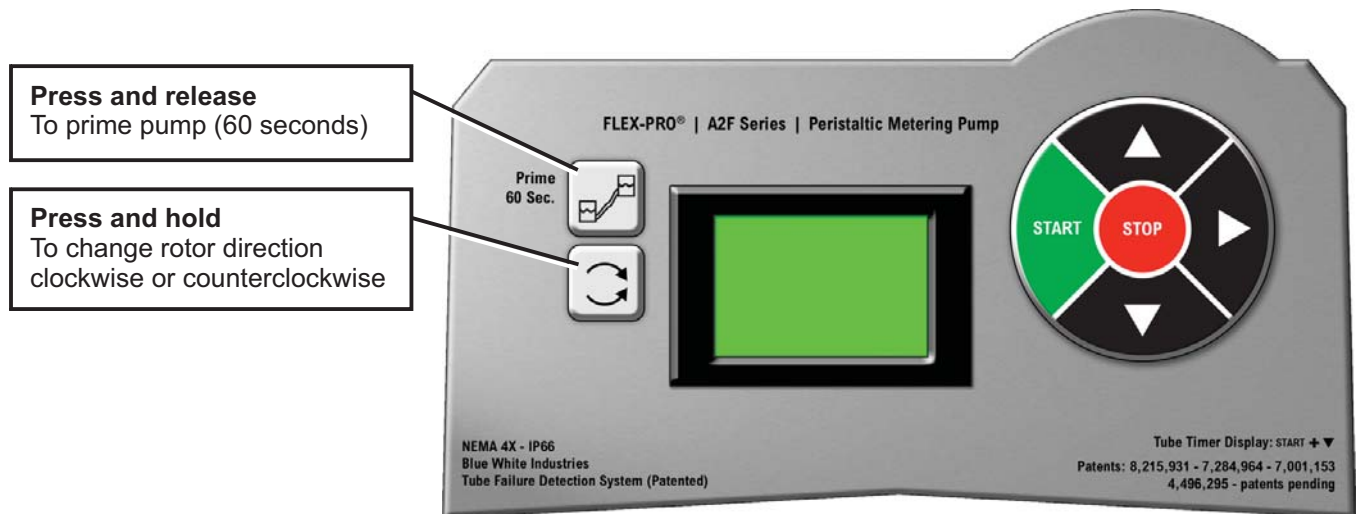

**Press and release**  
To prime pump (60 seconds)

**Press and hold**  
To change rotor direction  
clockwise or counterclockwise

**Press and release**  
Press UP arrow to increase  
pump speed (output) in Manual  
Operation.  
To increase value while in  
programming mode.

**Press and release**  
To Start pump.  
To begin listening (reacting) to  
external remote Start/Stop  
signal if enabled.

**Press and release**  
To Stop pump.

**Press and Hold**  
To configure selected Mode  
Remote Start / Stop  
FVS (flow verification system)

**Press and release**  
Press DOWN arrow to  
decrease pump speed (output)  
in Manual Operation.  
To decrease value while in  
programming mode.

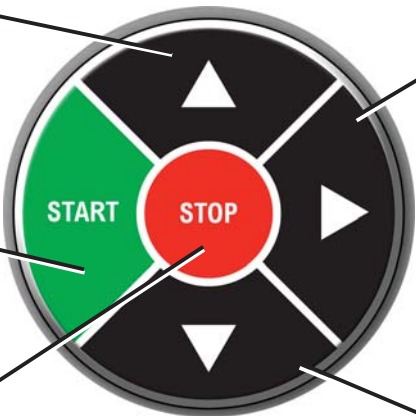

Tube Life Timer	
<p>To view amount of run time hours on currently installed tube.</p> <p>START + DOWN arrow displays current pump tube timer.</p> <p>Hold down START button, then press and release DOWN arrow.</p>	

## 7.0 Set Remote Start / Stop

Used to remotely start and stop pump using a dry contact closure signal.  
When activated; CLOSE = START and OPEN = STOP.

Set to NO = Remote Start / Stop is disabled  
Set to Yes = Remote Start / Stop is enabled

Can be used with external foot pedal, PLC, contact closure or other similar external devices.

Default setting = No (disabled)

### Step 1

Press and release STOP button

Note: Cannot enter programming mode while pump is in running.



### Step 2

Press and hold RIGHT arrow button until 'Remote' icon begins flashing.

Default setting 'NO' will also be visible when entering remote start / stop setup.

Note: If 'YES' had been selected previously, then 'YES' will be displayed on screen.

Remote  
Icon



### Step 3

Press and release DOWN arrow to change setting to 'YES.'

To change setting back to 'NO' press and release UP arrow.



### Step 4

After you've made your selection, press and release RIGHT arrow button. This saves your setting.

You can now modify FVS setting (see next page) or you can exit Setup by pressing and holding RIGHT arrow button for a few seconds until you return to Run screen.



Running pump with Remote Start / Stop enabled, 'REMOTE' icon will always be visible on lower left side of screen. Pump will display 'STBY' (standby) if pump is in stop mode via contact closure signal. **Please use caution in this mode, pump can start at anytime. If you must perform maintenance to pump, press and release STOP button.**

## 7.1 Set FVS (flow verification system)

Flow verification sensor sold separately.

Flow verification system is designed to stop pump in an event sensor does not detect flow during pump operation. Indicating an empty chemical tank, clogged injection fitting, loose tubing connection, etc.

To allow pump to clear any gasses that may have accumulated over time, an alarm delay time value from 1 to 255 seconds must be programmed.

Note: An alarm delay of 000 seconds disables FVS system.

### Step 1

Press and release STOP button

Note: Cannot enter programming mode while pump is in running.



### Step 2

Press and hold RIGHT arrow button until 'Remote' icon begins flashing.

This indicates that you've entered Setup menu.

Remote  
Icon



### Step 3

Press and release RIGHT arrow to scroll through menu until you see FVS icon.

If you pass FVS screen, continue to press and release RIGHT arrow button until FVS icon appears.



### Step 4

FVS icon will appear for 1 second, followed by numbers.

These numbers indicate delay time setting for FVS.

Select a delay time in seconds. Delay time is amount of time pump will wait to receive a pulse from sensor until an alarm it triggered.

A delay time of 00 deactivates FVS feature.



### Step 5

After you've made your selection, press and release RIGHT arrow button. This saves your setting.

Press and hold RIGHT arrow to exit Setup menu and return to runtime screen.



**Time-out** - Flex-Pro pumps have a time-out setting of 20 seconds while in configuration menus. If built-in timer exceeds 20 seconds without a button being pressed, then pump will exit configuration menu. Changes will only be saved after RIGHT arrow button is pressed and released.

## 7.1 Set FVS (flow verification system) - Continued

Flow Verification Sensor is designed to give you two installation options.

Sensor can be installed:

- Directly on pumphead of A2 pump, suction side.
- Anywhere on suction side of A2 pump.

Wiring for sensor can be connected directly to an A2 pump. Pump will stop pumping if sensor detects no flow. A relay will then close allowing for remote alarm indication or initiation of a back-up injector pump. **Install FVS Flow Sensor** - Flow Verification Sensor should be installed on inlet (suction) side of pump tube. Sensor includes a PVC tubing insert, located inside sensors female thread connection, that is designed to seal sensor onto pump tube inlet adapter. Thread sensor onto pump tube until tubing insert is snug against pump tube inlet fitting - do not over-tighten.

Sensor Model Number	Published Flow Range	Actual Working Range with Flex-Pro Pump
	ML/Min	ML/Min
FV-100	30-300	30-200
FV-200	100-1000	50-900
FV-300	200-2000	100-1800
FV-400	300-3000	300-3000
FV-500	500-5000	500-5000
FV-600	700-7000	700-7000



**Confirm FVS flow range** - Flow Verification Sensor (FVS) will only function within its operating range. See chart for available ranges.

Example: Sensor model FV-100 has an operation range of 30-300 ml/min when used as a flowmeter. However, due to pressure drop across sensor, pump's suction capability is limited to 14.7 psi. When used as a Flow Verification Sensor with a peristaltic pump, effective operating range is reduced to 30-200 ml/min.

NOTE: If pump output is less than 30 ml/min, sensor will not detect chemical and a signal will not be sent to pump, resulting in an alarm condition.

NOTE: For low viscosity (water-like) fluids only. Consult factory if attempting to use with viscous fluids.

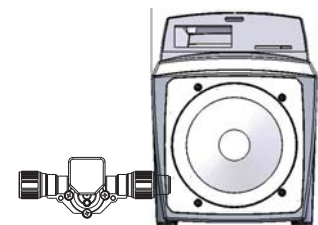

## 8.0 Manual Operation

Used to manually control speed of pump.

Use UP and DOWN arrows to adjust speed while pump is running.

To select exact run speed, follow steps below.

### Runtime Screen Shot 1

Displays motor speed percentage.  
Pump Running in Manual Operation



### Runtime Screen Shot 2

Displays motor speed percentage.  
Pump Running in Manual Operation with Remote Start /  
Stop enabled (see page 11).

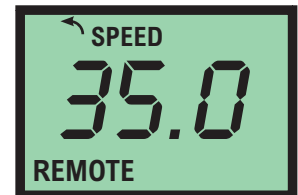

### Runtime Screen Shot 3

Displays 'Stand-By' status with Remote start/stop enabled  
and waiting for signal to start.

**Caution**, pump can start up at anytime in this condition.  
Press STOP button before performing maintenance.

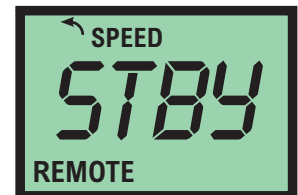

### Runtime Screen Shot 4

Display tube life timer.  
Press and hold START button.  
Press and release DOWN arrow.

Displays amount of total runtime hours on currently installed tube.  
Time will be displayed in hours.  
Timer will be display for approximately 5 seconds before returning to  
previous runtime screen.



Hours

With pump operating in manual operation, pump speed can be changed at anytime by using UP or DOWN arrows during operation.

## 9.0 Pump Tube Timer

Flex-Pro has a built in Pump Tube Timer. Timer starts when rotor is rotating and stops when rotor is idle.

To view current Pump Tube Timer value, press and hold START button, then press and release DOWN arrow.

Tube Timer screen will appear. Screen will display current Pump Tube Time in run-time hours. Tube Timer screen will display for 4 seconds and then switch back to previous operating display screen.

While displayed, press START button twice to reset Pump Tube Timer to zero.

When replacing pump tube, pump will ask you if you'd like to reset Pump Tube Timer. If you choose YES, screen will display current Pump Tube Time for 5 seconds before timer is reset to zero.

### Tube Life Timer

Display tube life timer.  
Press and hold START button.  
Press and release DOWN arrow.

Displays amount of total runtime hours on currently installed tube.  
Time will be displayed in hours.  
Timer will be display for approximately 5 seconds before returning to previous runtime screen.

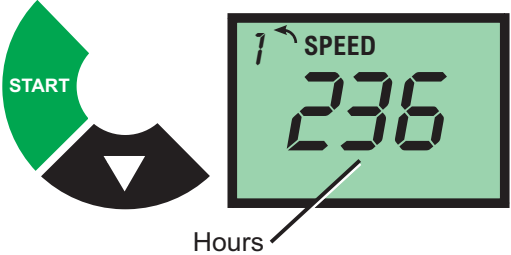

## 10.0 TFD (Tube Failure Detection)

Flex-Pro is equipped with a *Tube Failure Detection System* which is designed to stop pump and provide an output alarm in event pump tube should rupture and chemical enters pump head. Pump will detect a chemical with a conductivity reading greater than 500 microsiemens. Chemicals with a conductivity of less than 500 microsiemens will not be detected.

This patented system is capable of detecting presence of a large number of chemicals including Sodium Hypochlorite (Chlorine), Hydrochloric (muriatic) Acid, Sodium Hydroxide, and many others. System will not be triggered by water (rain, condensation, etc.) or silicone oil (roller and tubing lubricant).

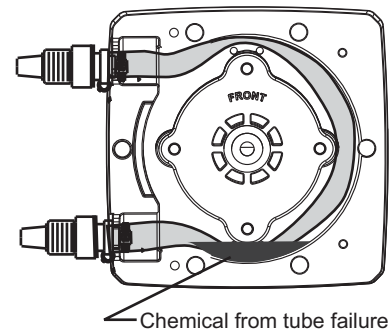

If system has detected chemical, pump tube must be replaced and pump head and roller assembly must be thoroughly cleaned. Failure to clean roller assembly will void warranty.

If TFD alarm occurs, pump will stop, close an alarm output, and screen will flash TFD with an alarm icon.

### Confirm Chemical Detection

To determine if your chemical will be detected by system, remove pump head cover and pump tube and roller assembly.

Place a small amount of chemical in bottom of pump head - just enough to cover sensors. Replace pump head cover only.

Turn on pump (press start). If TFD system detects chemical, pump will stop after a two second confirmation period and TFD Alarm screen will display. If TFD system does not detect chemical, pump will continue to run after confirmation period.

Carefully clean chemical out of pump head being sure to remove all traces of chemical from sensor probes. Replace roller assembly and tubing. Replace pump head cover. Press START button to clear alarm condition and restart pump.

## 11.0 Alarm Relay

Pump has a built in 6 amp alarm output relay. Relay is pre-configured to energize on tube failure detection (TFD) and on Flow Verification Sensor (FVS).

A Flow Verification Sensor must be installed and configured for relay to trigger on no-flow conditions.

## 12.0 Reverse Rotor Rotation

**CAUTION**  Prior to service, pump clean water through pump and suction / discharge line to remove chemical.

**CAUTION**  Always wear protective clothing, face shield, safety glasses and gloves when working on or near your metering pump. Additional precautions should be taken depending on solution being pumped. Refer to MSDS precautions from your solution supplier.

Reverse rotation of pump; press and hold REVERSE ROTATION button until rotor begins rotating in opposite direction. This process can be used for many reasons throughout various industries.

Two reasons for reversing current rotor rotation; to purge chemical from tubing and to extend tube life.

Plan ahead before reversing rotor rotation. If check valves are installed, make necessary arrangements to allow back flow.

**CAUTION**  Failure to install check valves in their proper flow direction can cause excess pressure (PSIg) build up in system and can result in tube rupture. Always use extreme caution and ensure proper connections when using this feature.

If your desire is to simply extend tube life:

Typically tubing fails on outlet side (pressure side) of tube assembly in pump head.

Reversing rotation, moves outlet side (pressure side) to opposite side of tube assembly, greatly increasing tube life.

Stop pump before tube failure occurs.



Disconnect power from pump. Carefully purge any pressure in discharge line of pump. Disconnect suction end tubing and discharge end tubing from pump head tubing.

**IMPORTANT!** Swap sides of suction (inlet) and discharge (outlet) tubing. No need to remove Pump Head Cover.

Double check all connections before starting pump.

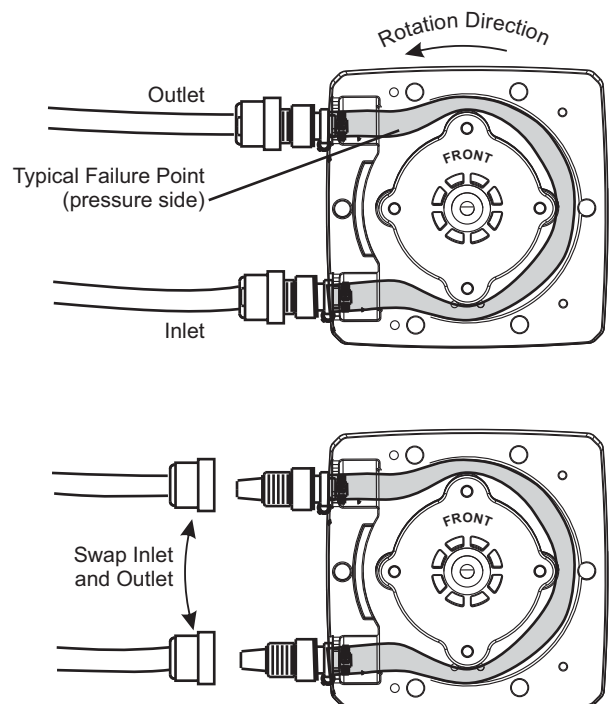



### 13.0 Tube Replacement

<b>CAUTION</b> ⚠	Prior to service, pump clean water through pump and suction / discharge line to remove chemical.
<b>CAUTION</b> ⚠	Always wear protective clothing, face shield, safety glasses and gloves when working on or near your metering pump. Additional precautions should be taken depending on solution being pumped. Refer to MSDS precautions from your solution supplier.
<b>CAUTION</b> ⚠	Use provided Tube Installation Tool to leverage tubing into pump head, <u>NOT YOUR FINGERS</u> .
<b>CAUTION</b> ⚠	Use extreme caution when replacing pump tube. Be careful of your fingers and <u>DO NOT place fingers near rollers</u> .

### 13.1 Tube Removal

**Step 1**

**Wear protective clothing, face shield, safety glasses and gloves during tube replacement.**

Relieve (remove) system pressure on discharge and suction side of pump. Failure to do so will cause solution to squirt when disconnecting tube connections. **SAFETY FIRST, REMOVE PRESSURE...**

Disconnect system plumbing from pump tube adapters.

**CAUTION**  
⚠

**Step 2**

Press and release STOP button.

Remove four black thumb screws from front of pump head cover. Turn screws counterclockwise to remove.

Remove pump head cover by pulling straight out.

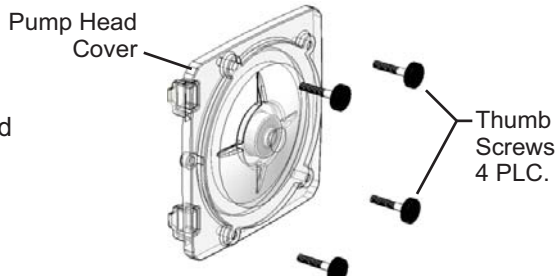

Pump Head Cover

Thumb Screws 4 PLC.

**Step 3**

With pump stopped, securely grab hold of suction side of tube adapter.

**CAUTION!** Keep fingers away from rollers and rotor.

Press and release START button to allow rotation of rotor.

Gently pull suction side tube adapter out, away from pump.



Suction side tube adapter

**Step 4**

Continue to pull suction side adapter out of pump head while rotor is in rotation.

Press and release STOP button.

Carefully pull discharge side of tube adapter out of pump head.

Dispose of used tubing properly.



Discharge side tube adapter

## 13.2 Tube Installation

**Before you begin.** Thoroughly clean Pump Head and Rotor. Rotor can be removed by pulling straight out. After cleaning process, push Rotor back on shaft. See drawing below for proper assembly. **IMPORTANT!** Rotor direction; word "FRONT" on Rotor must face forward (front of pump).

### Step 1

Press and release stop button to ensure pump is stopped.  
 With pump stopped, press suction side of tube adapter securely into pump head.  
 Clip Tube Installation Tool to discharge side of tube adapter.  
 Always keep fingers away from rollers and rotor.

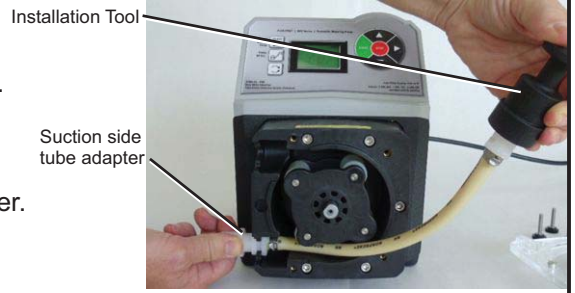

### Step 2

Your hand should only come in contact with installation tool.  
 Press and release START button.  
 Use installation tool to leverage tubing into pump head while rotor is rotating.

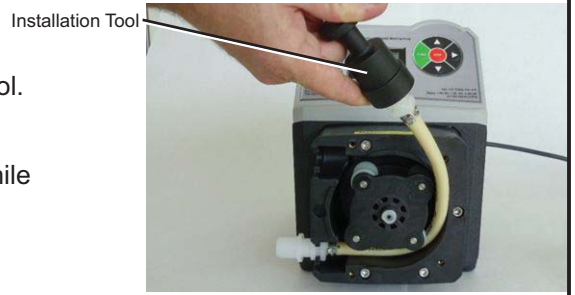

### Step 3

Continue to hold onto installation tool.  
 Allow rotor to rotate a few times, this will stretch tubing out.  
 After a few rotations, pull installation tool and tubing in direction of rotation.  
 Press discharge side of tube adapter securely into pump head.

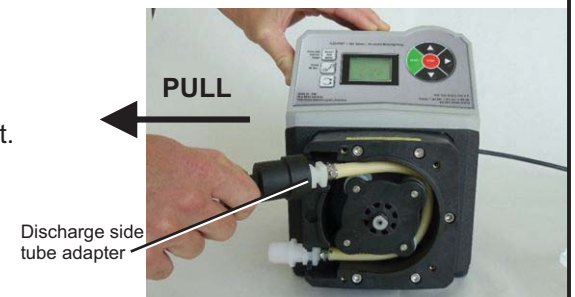

### Step 4

Press and release STOP button on pump.  
 Suction and discharge tube adapter ends should be securely held in place on pump head as illustrated in photo.  
 Secure pump head cover to pump head using four black thumb screws.

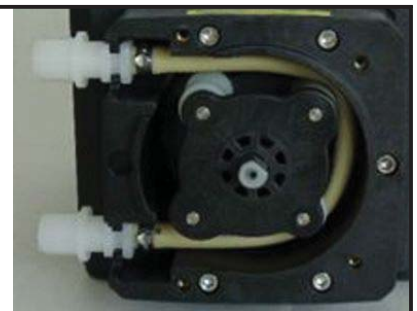

**Tube Installation Tool  
90002-278**

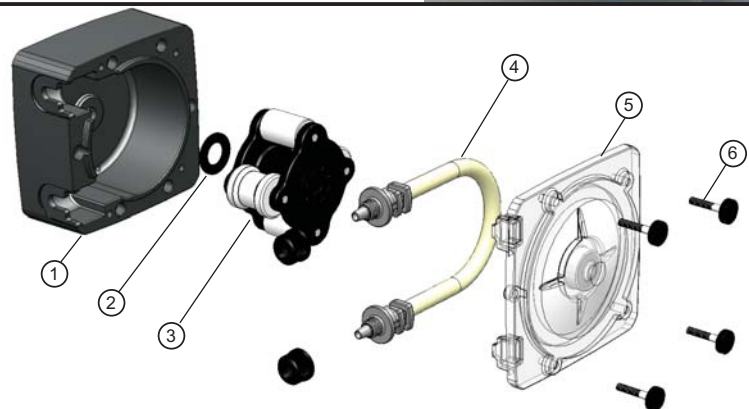

## 14.0 Pump Maintenance

**CAUTION**

Always wear protective clothing, face shield, safety glasses and gloves when working on or near your metering pump. Additional precautions should be taken depending on solution being pumped. Refer to MSDS precautions from your solution supplier.

### Routine Inspection and Maintenance

Pump requires very little maintenance. However, pump and all accessories should be checked weekly. This is especially important when pumping chemicals. Inspect all components for signs of leaking, swelling, cracking, discoloration or corrosion. Replace worn or damaged components immediately.

Cracking, crazing, discoloration during first week of operation are signs of severe chemical attack. If this occurs, immediately remove chemical from pump. Determine which parts are being attacked and replace them with parts that have been manufactured using more suitable materials. Manufacturer does not assume responsibility for damage to pump that has been caused by chemical attack.

### How to Clean and Lubricate Pump

Pump will require occasional cleaning. Amount will depend on severity of service.

☒ When changing pump tube assembly, pump head chamber, roller assembly and pump head cover should be wiped free of any dirt and debris.

☒ When changing pump tube assembly, wipe motor shaft with clean towel. Apply a small amount of grease to shaft. This will help prevent possibility of rotor sticking to motor shaft.

☒ Pump head cover bearing may require grease periodically. Apply a small amount of grease (Aeroshell aviation grease #5 or equivalent) when necessary.

☒ Although not necessary, 100% silicon lubrication may be used on roller assembly and tube assembly.

☒ Periodically clean injection/check valve assembly, especially when injecting fluids that calcify such as sodium hypochlorite. These lime deposits and other build ups can clog fitting, increase back pressure and interfere with check valve operation.

☒ Periodically clean suction strainer.

### 15.0 Pump Head Replacement Parts List

		Item	Description	Part Number	QTY
		2	Spacer, Back	90011-217	1
<b>Norprene®</b>	Tubing in this group are interchangeable with single roller assembly (rotor).	3	Roller Assembly Complete (Rotor), For ND Tubes	A2-SND-R	1
		4	Tube Assembly, 3/8" tube connect, Norprene ND (.075 ID)	A2-SND-T	1
		4	Tube Assembly, 1/2" Male NPT connect, Norprene ND (.075 ID)	A2-MND-T	1
		4	Tube Assembly, 3/4" tri-clamp, Norprene ND (.075 ID)	A2-CND-T	1
<b>Flex-A-Prene®</b>	Tubing in this group are interchangeable with single roller assembly (rotor).	3	Roller Assembly Complete (Rotor), For NEE and NGG Tubes	A2-SNGG-R	1
		4	Tube Assembly, Quick Disconnect, Flex-A-Prene NEE (0.93 ID)	A2-QNEE-T	1
		4	Tube Assembly, 1/4" Tube Compression, Flex-A-Prene NEE (0.93 ID)	A2-SNEE-T	1
		4	Tube Assembly, 1/2" Male NPT, Flex-A-Prene NEE (0.93 ID)	A2-MNEE-T	1
<b>Norprene® Chemical</b>	Tubing in this group are interchangeable with single roller assembly (rotor).	3	Roller Assembly Complete (Rotor), For TH Tubes	A2-STH-R	1
		4	Tube Assembly, 3/8" tube connect, Norprene Chemical TH (.250 ID)	A2-STH-T	1
		4	Tube Assembly, 1/2" Male NPT, Norprene Chemical TH (.250 ID)	A2-MTH-T	1
		4	Tube Assembly, 3/4" tri-clamp, Norprene Chemical TH (.250 ID)	A2-CTH-T	1
<b>Tygothane®</b>	Tubing in this group are interchangeable with single roller assembly (rotor).	3	Roller Assembly Complete (Rotor), For GE Tubes	A2-SGE-R	1
		4	Tube Assembly, 3/8" tube connect, Tygothane GE (.125 ID)	A2-SGE-T	1
		4	Tube Assembly, 1/2" Male NPT connect, Tygothane GE (.125 ID)	A2-MGE-T	1
		4	Tube Assembly, 3/4" tri-clamp, Tygothane GE (.125 ID)	A2-CGE-T	1
		5	Pump Head Cover, Polycarbonate - New design, backwards compatible	A2-SXX-C	1
		6	Thumb Screw	90011-183	4
		7	Tube Nut, Compression, For 3/8" Tubing	C-330-6	2
Not Shown			Stainless Steel mounting bracket kit (pair)	72000-379	1
Not Shown			Stainless Steel extended mounting bracket kit (pair)	72000-380	1
Not Shown			Rubber feet	90003-561	4

#### Flex-A-Prene® Upgrade Kit

Model #	Description
72000-539	Roller Assembly and Pump Head Cover

Upgrade existing A2 pumps with Flex-A-Prene® Upgrade Kit to be compatible with all new Flex-A-Prene® tubes.

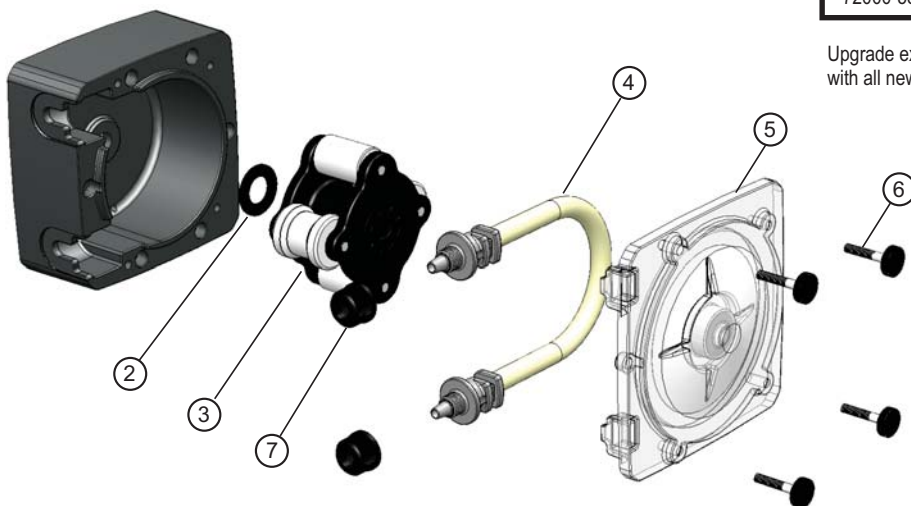

### 16.0 Output Versus Fluid Viscosity

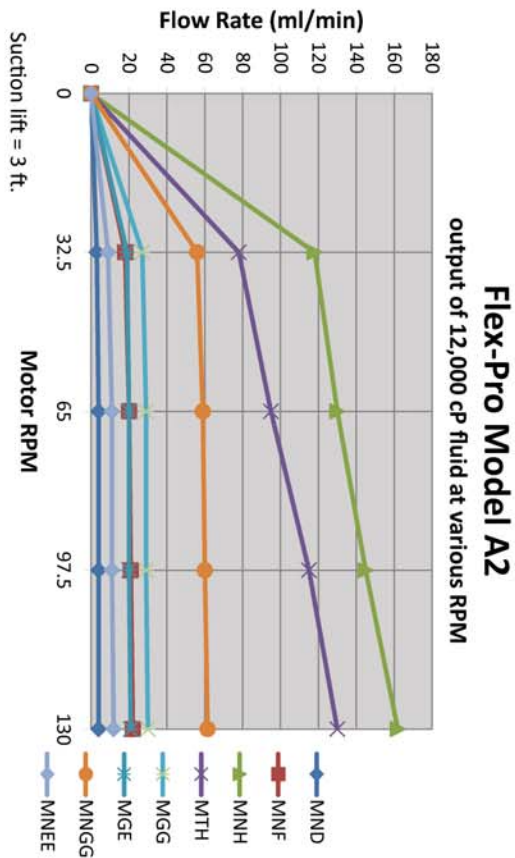
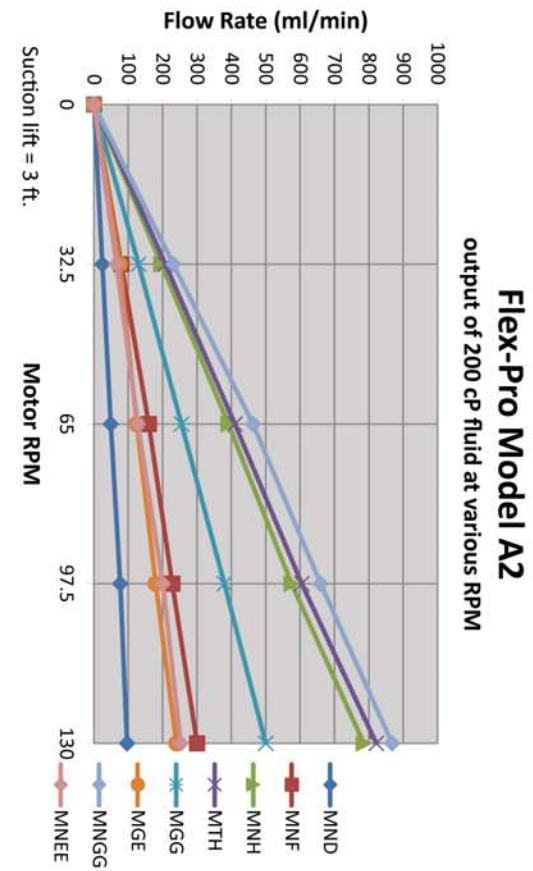
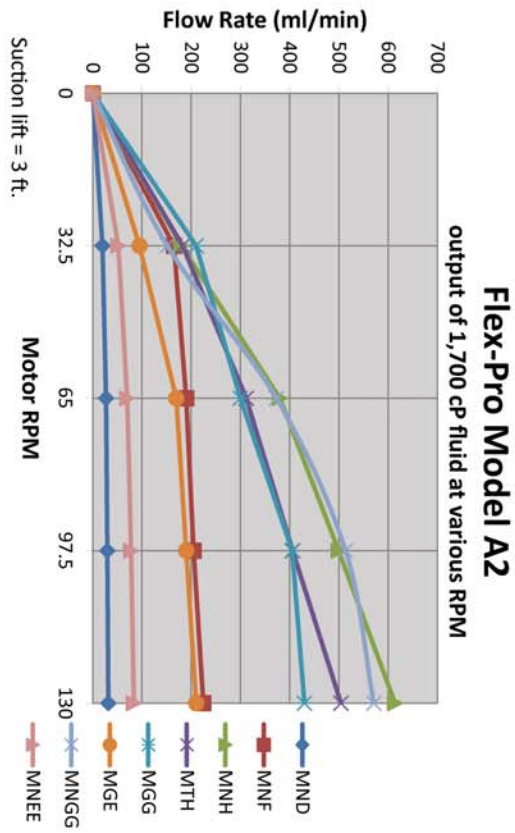
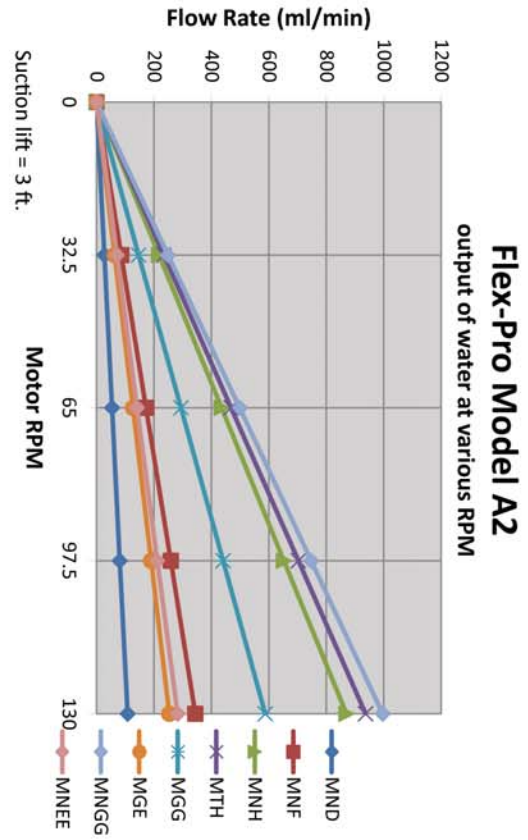

### LIMITED WARRANTY

Your new Flex-Pro pump is a quality product and is warranted for 24 months from date of purchase (proof of purchase is required). The pump will be repaired or replaced at our discretion. Pump Head and roller assembly is warranted against damage from chemical attack when proper TFD (Tube Failure Detection) system instructions and maintenance procedures are followed.

### WHAT IS NOT COVERED

- **Pump Tube Assemblies and rubber components – They are perishable and require periodic replacement.**
- **Pump removal, or re-installation, and any related labor charge.**
- **Freight to the factory, or ProSeries service center.**
- **Pumps that have been tampered with, or in pieces.**
- **Damage to the pump that results from misuse, carelessness such as chemical spills on the enclosure, abuse, lack of maintenance, or alteration which is out of our control.**
- **Pumps damaged by faulty wiring, power surges or acts of nature.**

Blue-White Industries does not assume responsibility for any loss, damage, or expense directly or indirectly related to or arising out of the use of its products. Failure must have occurred due to defect in material or workmanship and not as a result of operation of the product other than in normal operation as defined in the pump manual.

Warranty status is determined by the pump's serial label and the sales invoice or receipt. The serial label must be on the pump and legible. The warranty status of the pump will be verified by Blue-White Industries or a factory authorized service center.

### OTHER IMPORTANT WARRANTY INFORMATION

Please be advised; injection and metering devices are not intended as a means of treating water to render it suitable for human consumption. When used as hypochlorinators, they are meant to destroy bacteria and algae contamination, before its removal by filtration. Acid and soda injectors are used for PH control (balance). Blue-White Industries injectors are factory tested with water only for pressure and performance. Installers and operators of these devices must be well informed and aware of the precautions to be taken when injecting various chemicals -especially those considered hazardous or dangerous, eye protection must be worn when working around this product or any other metering type of pump.

Should it become necessary to return the pump for repair or service, you must attach information regarding the chemical used as some residue may be present within the unit which could be a hazard to service personnel.

Blue-White Industries will not be liable for any damage that may result by the use of chemicals with their injectors and its components. Thank you.

### PROCEDURE FOR IN WARRANTY REPAIR

Contact the factory to obtain a RMA (Return Material Authorization) number. Carefully pack the pump to be repaired. It is recommended to include foot strainer and injection/check valve fitting since these devices may be clogged and part of the problem. Please enclose a brief description of the problem as well as the original invoice or sales receipt, or copy showing the date of purchase. Prepay all shipping costs. COD shipments will not be accepted. Warranty service must be performed by the factory or an authorized ProSeries service center. Damage caused by improper packaging is the responsibility of the sender. When In-Warranty repair or replacement is completed, the factory pays for return shipping to the dealer or customer.



Users of electrical and electronic equipment (EEE) with the WEEE marking per Annex IV of the WEEE Directive must not dispose of end of life EEE as unsorted municipal waste, but use the collection framework available to them for the return, recycle, recovery of WEEE and minimize any potential effects of EEE on the environment and human health due to the presence of hazardous substances. The WEEE marking applies only to countries within the European Union (EU) and Norway. Appliances are labeled in accordance with European Directive 2002/96/EC. Contact your local waste recovery agency for a *Designated Collection Facility* in your area.

**ProSeries®**  
by Blue-White Ind.

5300 Business Drive, Huntington Beach, CA 92649 USA

Phone: 714-893-8529 FAX: 714-894-9492

E mail: sales@blue-white.com or techsupport@blue-white.com URL: www.blue-white.com