

LAKWOOD INSTRUMENTS
DIGITAL INPUT NODE (NDIG)
INSTALLATION & OPERATION MANUAL

SERIAL #: _____

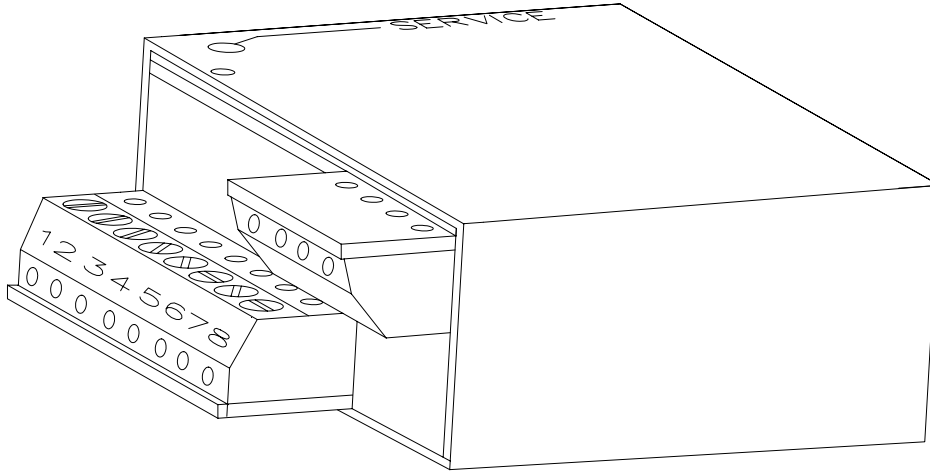

Lakewood Instruments

7838 North Faulkner Road, Milwaukee, Wisconsin 53224 USA

Phone (800) 228-0839 • Fax (414) 355-3508

<http://www.lakewoodinstruments.com>

Lakewood Instruments

We thank you for your selection and purchase of a Lakewood Instruments product.

With proper care and maintenance, this device should give you many years of trouble-free service. Please take the time to read and understand this Installation and Operation Manual, paying special attention to the sections on **OPERATION** and **MAINTENANCE**.

If, in the future, any parts or repairs are required, we strongly recommend that only original replacement parts be used. Our Customer Service Department is happy to assist you with your parts or service requests.

 **Lakewood Instruments Customer Service and Technical Support Departments can be reached by calling (800) 228-0839 or faxing (414) 355-3508, Monday through Friday, 7:30 a.m. - 5:00 p.m. CST.**

 **Mail should be sent to:**

**Lakewood Instruments
7838 North Faulkner Road
Milwaukee, WI 53224 USA**

DIGITAL INPUT NODE (NDIG)

Table of Contents

INTRODUCTION	7
Introduction	7
Specifications	8
INSTALLATION	9
Checking	9
Connections	9
Service Light	9
Operation with 2000 Series Controllers	10
CONFIGURATION	12
Configuration of Node	12
Configuration of Node with Relays	15
MAINTENANCE AND TECHNICAL SERVICE	17
Technical Service	17
Service Guide	17
Troubleshooting	18
DRAWINGS	19

INTRODUCTION

NDIG

The Model NDIG Node is a LONWORKS[®] compatible node that uses twisted pair communications. It accepts four digital inputs which can be tied into most 2000 series controllers. Up to two NDIG nodes may be installed on the 2000 series controller for a total of eight digital inputs.

<p>NOTE: To use the NDIG with a 2000 series controller it must have the NIN option and contain Rel 98 Firmware. All controllers shipped after 1 June 98 will have Rel 98 firmware.</p>

Additional water meters and relay outputs.

After a NDIG is installed, not only will you be able to view external digital inputs you will also be available to control relays based on the external input. In addition the first node of the possible two that can be installed allows you to configure input 1 and 2 for water meters.

LONWORKS is a registered trademark of Echelon Corporation.

Specifications

Inputs	Four digital inputs. Channels one and two may be used as water meter inputs. Contacting head or open collector type meters may be used.
Network wiring distance	400 meters from furthest node
Power	24 VDC

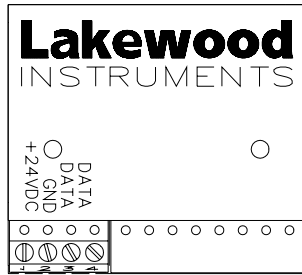

Network and Power connections

Connection to NIN and other nodes as well as 24 VDC.

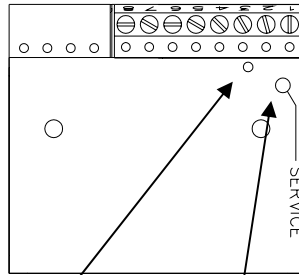

Service Light

Service Pin

Indicates node status. Installs node on network.

INSTALLATION

Checking

Inspect the shipping carton for obvious external damage. Note on the carrier's bill-of-lading the extent of the damage, if any, and notify the carrier. Save the shipping carton until your Node is started up.

📞 If shipping damage has occurred, call the Lakewood Instruments Customer Service Department at (800) 228-0839 and return the controller to the factory in the original carton.

Connections

The NIN option is required on the 2000 series controller for the NDIG to operate. The NIN option provides power and two way communications to the NDIG. Refer to the drawings in the back of this manual for wiring details.

Service Light

The service light is used for installation of the node and for troubleshooting. Below is a chart of what the service light might indicate during operation.

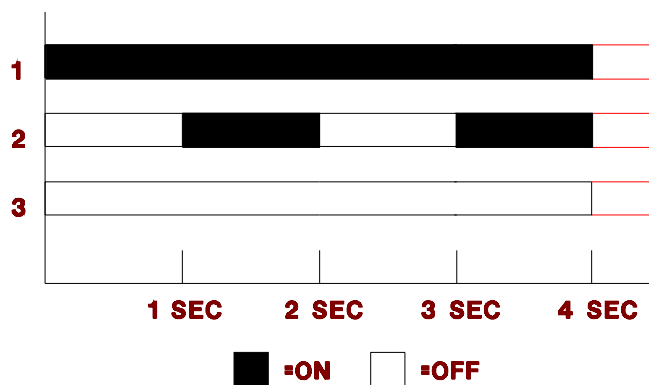

Behavior	Description	Resolution
1	Bad Node	Replace Node
2	Node is unconfigured,	Install Node
3	Node is running normally	none
3	Node does not have power	Check power supply

Light will also be on while the service button is pressed.

Operation with 2000 Series Controllers

Before it can be used, the NDIG must be installed into the software of the controller.

Under the **Main Menu**,

```
          MAIN MENU
          =====
3 FEED SCHEDULE
4 ALARMS
5 WATER METERS
6 4-20 MA OUTPUTS
7 SYSTEM SETUP
8 CLOCK
```

highlight **SYSTEM SETUP**, then press **ENT**. You should see the following screen:

```
          SYSTEM SETUP
          =====
1 PROCESS PARAMETERS
2 INITIALIZATION
3 DIGITAL INPUTS
4 FIRMWARE VERSIONS
5 SECURITY
6 DIAGNOSTICS
7 COMMUNICATIONS
8 NODE INSTALLATION
```

Highlight **NODE INSTALLATION**, then press **ENT**. You should see the following screen:

```
          NODE INSTALLATION
          =====
1 INSTALL A NEW NODE
2 DE-INSTALL A NODE
```

Highlight **INSTALL A NEW NODE**, then press **ENT**. You should see the following screen:

```
INSTALL A NEW NODE
=====
1 RELAYS 5-8
2 RELAYS 9-12
3 MAKEUP COND
4 REMOTE SENSOR
5 REMOTE SENSOR
6 REMOTE SENSOR
7 REMOTE SENSOR
8 ANOLOG INPUTS (4)
9 ANOLOG INPUTS (4)
10 DIGITAL INPUTS (4)
11 DIGITAL INPUTS (4)
```

Select which node to install.

NOTE: YOU MUST ASSIGN YOUR NDIG TO DIGITAL INPUTS (4).

The following screen should appear:

```
PRESS SERVICE PIN

PRESS ANY KEY
```

Momentarily press the Service Pin on the node to be installed. The Service Light should turn on while the Service Pin is pressed. After the Service pin is released press any key on the key pad and the node will be installed.

CONFIGURATION

Configuration of Node

For the NDIG to work properly with different sensors it must be configured properly.

Under the **Main Menu**,

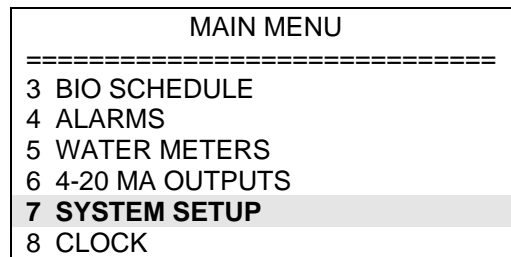

highlight **SYSTEM SETUP**, then press **ENT**. You should see the following screen:

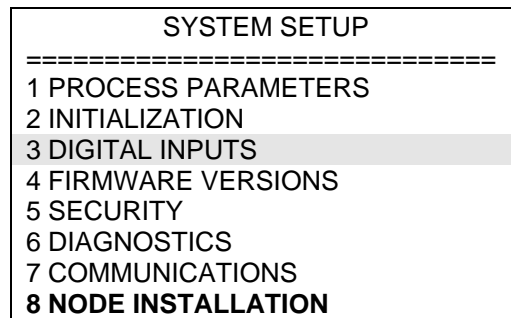

Highlight **DIGITAL INPUTS**, then press **ENT**. You should see the following screen:

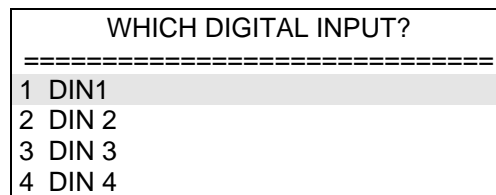

Highlight the appropriate input and press **ENT**. You should see the following screen:

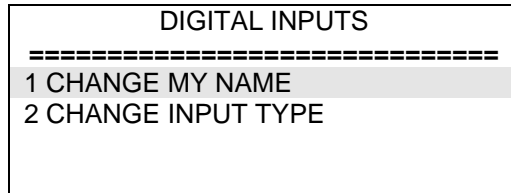

You may change the name of the input to be something other than DIG1. To do this select **CHANGE MY NAME** then press **ENT**.

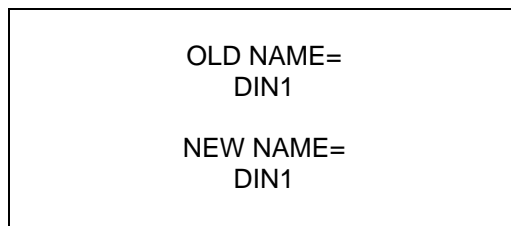

Use the \uparrow or \downarrow keys to change the character. Press **ENT** to go to the next character.

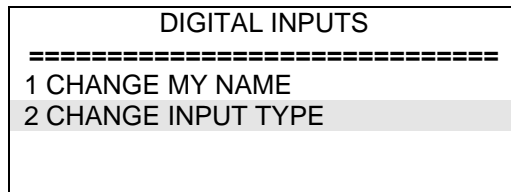

Highlight **CHANGE INPUT TYPE** and press **ENT**. You should see the following screen:

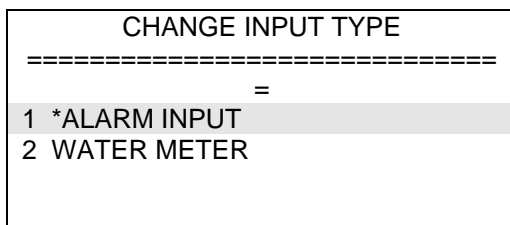

Highlight **ALARM INPUT** and press **ENT**. You will see the following screen:

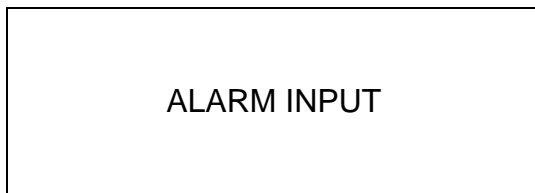

The digital input is configured to be an Alarm Input.

To configure for water meter input do the following:

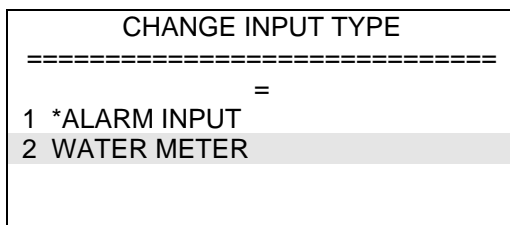

Highlight **WATER METER** and press **ENT**. You will see the following screen:

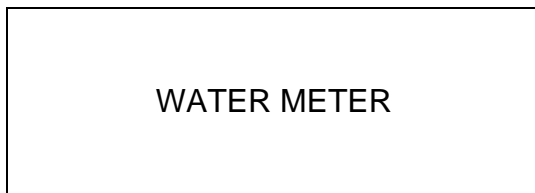

The digital input is configured to be a water meter input. Refer to your 2000 series instruction manual for configuring the water meter input.

Configuration of Node with Relays

The NDIG can be used to control relays in the 2000 series controller or the NRLY node.

Under the **Main Menu**,

```

                MAIN MENU
            =====
1 PROCESS
2 RELAYS
3 BIO SCHEDULE
4 ALARMS
5 WATER METERS
6 4-20 MA OUTPUTS
7 SYSTEM SETUP
8 CLOCK

```

highlight **RELAYS**, then press **ENT**. You should see the following screen:

```

                WHICH RELAY?
            =====
                =
1 BLOW
2 RLY2
3 RLY3
4 RLY4

```

Highlight the appropriate relay , then press **ENT**. You should see the following screen:

```

                RLY2
            =====
                =
1 DISABLE
2 SETPOINT
3 WATER METER
4 PERCENT BLOWDOWN
5 PERCENT OF TIME
6 FEED SCHEDULE
7 ALARM RELAY
8 CHANGE MY NAME
9 SCHEDULE LOCKOUT?

```

Highlight **ALARM RELAY** , then press **ENT**. You should see the following screen:

WHICH ALARMS	
=====	
1	CONTOLLER
2	RELAYS 5-8
3	RELAYS 9-12
4	MAKEUP COND
5	REMOTE SENSOR
6	REMOTE SENSOR
7	REMOTE SENSOR
8	REMOTE SENSOR
9	ANOLOG INPUTS (4)
10	ANOLOG INPUTS (4)
11	DIGITAL INPUTS (4)
12	DIGITAL INPUTS (4)

Highlight the appropriate Input , then press **ENT**. You should see the following screen:

WHICH ALARMS?	
=====	
1	DIN1: CONTACT CLOSE
2	DIN2: CONTACT CLOSE
3	DIN3: CONTACT CLOSE
4	DIN4: CONTACT CLOSE

Highlight the appropriate input, then press **ENT**. You should see a * placed next to the choosen input. Press **ENT** to remove the *. You may select any combination of inputs to actuate the relay.

Maintenance and Technical Service

Technical Service

-  Technical Support for Lakewood Instruments can be reached by calling (800) 228-0839 or faxing (414) 355-3508, Monday through Friday, 7:30 a.m. – 5.00 p.m. CST.

NOTE: IF YOU CALL FOR TROUBLESHOOTING HELP, PLEASE HAVE THE MODEL NUMBER, SERIAL NUMBER, AND ANY OPTIONS PERTAINING TO YOUR UNIT AVAILABLE FOR REFERENCE.

-  Mail and returns should be sent to:

**Lakewood Instruments
7838 North Faulkner Road
Milwaukee, WI 53224 USA**

When any merchandise is to be returned to the factory, please call and obtain a Return Goods Authorization (RGA) number and have the following information available:

- Customer's name, address, telephone and fax numbers (shipping and billing).
- A hard copy purchase order number for cases where repairs or parts are required that are not under warranty.
- A contact person's name and telephone number to call if the equipment is beyond repair or to discuss any other warranty matter.
- Equipment model and serial numbers.
- Reason for return, e.g., repair, warranty, incorrect part, etc.

We will then fax to your attention an RGA form that must accompany the returned item.

NOTE: THE RGA NUMBER MUST BE CLEARLY WRITTEN ON THE OUTSIDE OF THE PACKAGE(S) BEING RETURNED.

**ANY ITEMS SENT BACK TO THE FACTORY
WITHOUT AN RGA NUMBER WILL BE REFUSED
AND RETURNED TO SENDER**

Troubleshooting

PROBLEM	WHAT THIS MEANS	CORRECTIVE ACTION
Screen Displays "DINx CONTACT CLOSED"	The contact on the digital input is closed.	None, this is normal operation.
Service light flashes on node	Node is not installed	Install the node.
Watermeter values do not change	NDIG is not seeing a input from the water meter	Check wiring. Check for proper water meter configuration If using contacting head, remove wires and manually create a contact. If display increments, water meter is not functioning.
LRWS does not display flow rate for water meter	Digital input is configured for contacting head watermeter.	No flow rate can be displayed on LRWS with contacting head water meter.

REVISION HISTORY						
REV	ZONE	DESCRIPTION	ECO	DWN	DATE	APPD
A		RELEASE	1045	EV	9/5/97	

NOTES: UNLESS OTHERWISE SPECIFIED:
 1. NIN OPTION PROVIDES +24 VDC TO ALL NODES.
 IF USING MORE THAN 3 NODES AN EXTERNAL
 +24 VDC POWER SUPPLY IN PARALLEL IS
 RECOMMENDED.

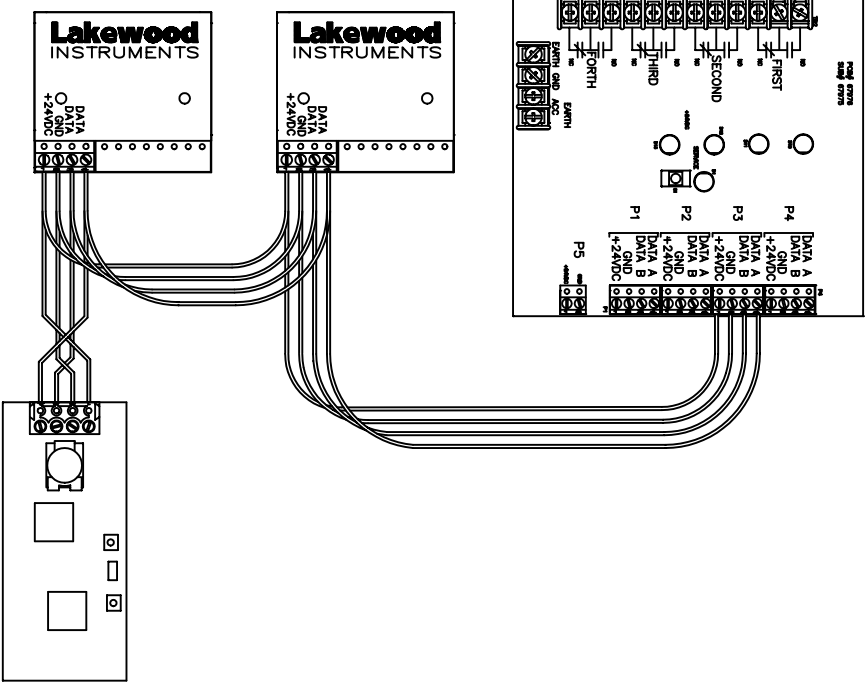

OR

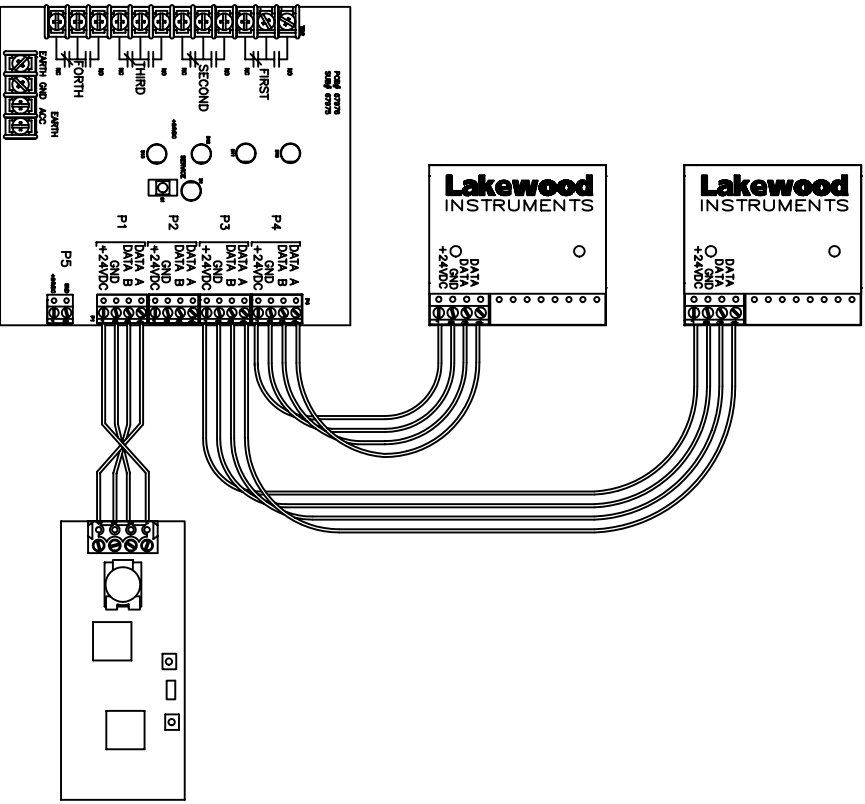

NOTICE ON REPRODUCTIONS: THIS DRAWING IS THE PROPERTY OF OSMONICS INC. AND IS NOT TO BE REPRODUCED OR TRANSMITTED IN ANY FORM OR BY ANY MEANS, ELECTRONIC OR MECHANICAL, INCLUDING PHOTOCOPYING, RECORDING, OR BY ANY INFORMATION STORAGE AND RETRIEVAL SYSTEM, WITHOUT THE WRITTEN PERMISSION OF OSMONICS INC. ANY UNAUTHORIZED REPRODUCTION OR TRANSMISSION IS STRICTLY PROHIBITED AND WILL BE LEGALLY PROSECUTED.



OSMONICS
 PRECISION OPERATIONS

INSTALLATION DRAWING
 NIN OPTION

FRAC	DECIMALS	ANGLES	TITLE
1/16	.XX ± .01	±.5°	INSTALLATION DRAWING
DWG NO.	DATE	DATE	DWG NO./REV
04263	9/5/97	9/5/97	04263
CUSTOMER LOC.	APPD	DATE	SCALE
	APPD	DATE	NONE
DO NOT SCALE	APPD	DATE	FILE TYPE: DWG
	APPD	DATE	SHEET 1 OF 1

A B C D

4

3

2

1

PN 6027 REV-A Pcs/2

NOTES: UNLESS OTHERWISE SPECIFIED:

1. DATA TWISTED PAIR SPECIFICATIONS:
 BELDON 85102, SINGLE TWISTED PAIR, STRANDED 9/29, UNSHIELDED, PLENUM,
 BELDON 8471, SINGLE TWISTED PAIR, STRANDED 9/29, UNSHIELDED, NONPLENUM,
 JY (ST) Y 2 X 2 X 2 X 8, UL LEVEL IV 22 AWG, TWISTED PAIR, TYPICALLY SOLID
 AND UNSHIELDED, FOUR WIRE HELICAL TWIST, SOLID, SHIELDED.
2. IF SHIELDED CABLE IS USED, THE SHIELD SHOULD BE CONNECTED TO EARTH
 GROUND VIA A 470K OHMS, .25 WATT, METAL FILM RESISTOR TO PREVENT
 STATIC CHARGE BUILD-UP.
3. MAXIMUM POWER REQUIREMENT 23 MA @ 24 VDC.

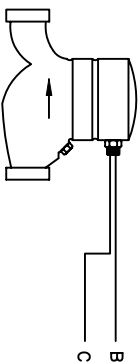

2535, 2540

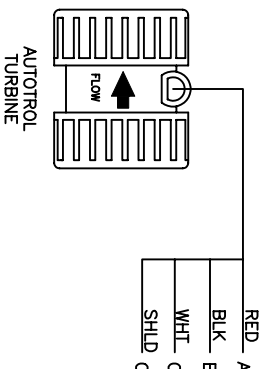

(DRY CONTACT CONNECTION)

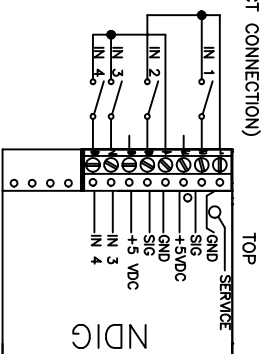

(WATER METER CONNECTION)

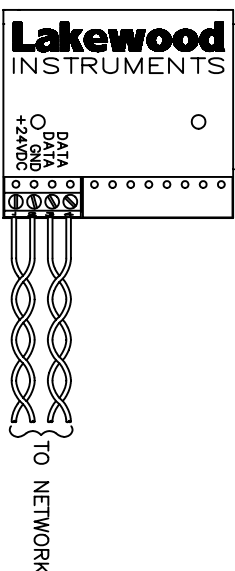
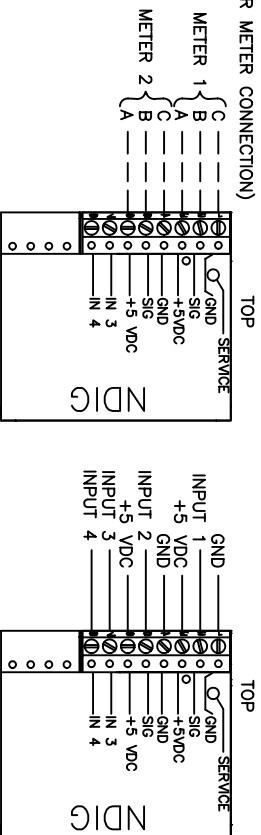

REVISION HISTORY

REV	DESCRIPTION	ECO	DWN	DATE	APVD
1	RELEASE	0732	EV	8/5/97	

NOTICE ON REPRODUCTIONS

THIS DRAWING, THE DESIGN AND THE PATENTS IT COVERS ARE THE PROPERTY OF OSMONICS. ANY REPRODUCTION OR TRANSMISSION OF THIS DRAWING OR AGREEMENT THAT THEY WILL NOT BE REPRODUCED, COPIED, LOANED, EXHIBITED, EITHER WHOLLY OR IN PART, OR IN ANY MANNER, WITHOUT THE WRITTEN CONSENT GIVEN BY THE ENGINEER TO THE ENGINEER.



PHOENIX OPERATIONS

COMPONENT ASSEMBLY

WIRING, NDIG

FINISH	FRAC DECIMALS	ANGLES	TITLE	SIZE	DWG NO/PN	REV
	.XX ± .03	.X ± .1	COMPONENT ASSEMBLY	B	04560	1
ORDER NO.	DMN EV	DATE 8/5/97	DATE	THIRD ANGLE	FILE TYPE: DWG	SHEET 1 OF 1
CUSTOMER	CHKD	DATE	DATE	SCALE: NONE		
CUSTOMER LOC.	APVD	DATE	DATE			
DO NOT SCALE	APVD	DATE	DATE			

For more information call toll free in the USA (800) 228-0839

Manufactured in the USA

Lakewood Instruments

*7838 North Faulkner Road, Milwaukee, WI 53224 USA
Phone (800) 228-0839 • Fax (414) 355-3508
<http://www.lakewoodinstruments.com>*