

WALCHEM

An Iwaki America Company

WDC400 Controllers

WDC400 Series Dual Condensate Conductivity Monitor Instruction Manual

Five Boynton Road Hopping Brook Park Holliston, MA 01746 USA

TEL: 508-429-1110 FAX: 508-429-7433 WEB: www.walchem.com

Notice

© 2009 WALCHEM, An Iwaki America Incorporated Company (hereinafter "Walchem")
5 Boynton Road, Holliston, MA 01746 USA
(508) 429-1110
All Rights Reserved
Printed in USA

Proprietary Material

The information and descriptions contained herein are the property of WALCHEM. Such information and descriptions may not be copied or reproduced by any means, or disseminated or distributed without the express prior written permission of WALCHEM, 5 Boynton Road, Holliston, MA 01746.

This document is for information purposes only and is subject to change without notice.

Statement of Limited Warranty

WALCHEM warrants equipment of its manufacture, and bearing its identification to be free from defects in workmanship and material for a period of 24 months for electronics and 12 months for mechanical parts from date of delivery from the factory or authorized distributor under normal use and service and otherwise when such equipment is used in accordance with instructions furnished by WALCHEM and for the purposes disclosed in writing at the time of purchase, if any. WALCHEM's liability under this warranty shall be limited to replacement or repair, F.O.B. Holliston, MA U.S.A. of any defective equipment or part which, having been returned to WALCHEM, transportation charges prepaid, has been inspected and determined by WALCHEM to be defective. Replaceable elastomeric parts and glass components are expendable and are not covered by any warranty.

THIS WARRANTY IS IN LIEU OF ANY OTHER WARRANTY, EITHER EXPRESS OR IMPLIED, AS TO DESCRIPTION, QUALITY, MERCHANTABILITY, FITNESS FOR ANY PARTICULAR PURPOSE OR USE, OR ANY OTHER MATTER.

180333.G
Mar 2009

TABLE OF CONTENTS

1.0	INTRODUCTION	1
2.0	SPECIFICATIONS	1
2.1	Measurement Performance	1
2.2	Electrical: Input/Output	1
2.3	Mechanical	2
2.4	WDC Variables and their Limits	2
3.0	UNPACKING & INSTALLATION	3
3.1	Unpacking the unit	3
3.2	Mounting the electronic enclosure	3
3.3	Installation	3
3.4	Icon Definitions	3
3.5	Electrical installation	4
4.0	FUNCTION OVERVIEW	8
4.1	Front Panel	8
4.2	Display	8
4.3	Keypad	9
4.4	Access Code	9
4.5	Startup	9
4.6	Shut Down	10
5.0	OPERATION	10
5.1	Main Menu	10
5.2	Conductivity (A or B) Menu	12
5.3	Temperature (A or B) Menu	13
5.4	Divert (A or B) Menu	14
5.5	Time Menu	15
5.6	4-20mA (A or B) Menu	16
5.7	Access Code Menu	17
5.8	Datalog Menu	18
5.9	Config Menu	20
5.10	Upgrade Menu	21
6.0	MAINTENANCE	22
6.1	Electrode Cleaning	22
6.2	Replacing the Fuses	22
7.0	TROUBLESHOOTING	23
7.1	Error Messages	23
7.2	Conductivity Readout Does Not Change	24
7.3	Procedure for Evaluation of Conductivity Electrode	24
7.4	Procedure for checking relay outputs	24
8.0	SERVICE POLICY	25

1.0 INTRODUCTION

The Walchem WDC400 Series monitors offer conductivity control of boiler condensate of two separate boilers. If the conductivity rises above the set point, the controller will activate a diverter valve to prevent the contaminated condensate from returning to the boiler and/or set off an alarm.

The WDC series condensate monitors are supplied with a temperature compensated electrode with a cell constant of 1.0. The monitors are microprocessor driven industrial type with on/off control outputs. One or two optional isolated 4-20 mA outputs that are proportional to the conductivity reading are available for all models.

Any set point may be viewed without interrupting control. Each set point change will take effect as soon as it is entered. An access code is available to protect set point parameters, while still allowing settings to be viewed.

2.0 SPECIFICATIONS

2.1 Measurement Performance

Conductivity Range	0 - 10,000 μ S/cm (microSiemens/centimeter)
Conductivity Resolution	1 μ S/cm
Conductivity Accuracy	10 - 10,000 μ S/cm \pm 1% of reading 0 - 10 μ S/cm \pm 20% of reading
Temperature Range	32 - 158°F (0 - 70°C)
Temperature Resolution	0.1°C
Temperature Accuracy	\pm 1% of reading

2.2 Electrical: Input/Output

Input Power	100-240 VAC, 50/60 Hz, 8A Fuse: 1.0 ampere, 5 x 20 mm
Outputs	
Mechanical Relays	Pre-powered on circuit board switching line voltage 6 A (resistive), 1/8 HP All relays are fused together as one group, total current for this group must not exceed 6A.
4 - 20 mA (optional)	Internally powered Fully isolated 600 Ohm max resistive load Resolution .001% of span Accuracy \pm 1% of reading
Agency Approvals	
UL	ANSI/UL 61010-1:2004, 2 nd Edition*
CAN/CSA	C22,2 No.61010-1:2004 2 nd Edition*
CE Safety	EN 61010-1 2 nd Edition (2001)*
CE EMC	EN 61326 :1998 Annex A*

Note: For EN61000-4-6,-3 the monitor met performance criteria B.

*Class A equipment: Equipment suitable for use in establishments other than domestic, and those directly connected to a low voltage (100-240 VAC) power supply network which supplies buildings used for domestic purposes.

2.3 Mechanical

Enclosure Material	Polycarbonate
NEMA Rating	NEMA 4X
Dimensions	8.5" x 6.5" x 5.5"
Display	2 x 16 character backlit liquid crystal
Operating Ambient Temp	32 – 122°F (0 – 50°C)
Storage Temperature	-20 – 180°F (-29 – 80°C)
Electrode mounting	¾" NPTF
Electrode rating	250 psi at 392°F (17.2 bars at 200°C)
Electrode material	316 SS and PEEK

2.4 WDC Variables and their Limits

		Low Limit	High Limit
Conductivity menu			
	PPM Conversion Factor	0.200 ppm/μS/cm	1.000 ppm/μS/cm
	Interval Time (sampling)	5 minutes	24:00 hours
	Duration Time (sampling)	1 minute	59 min: 59 sec
	% Calibration Range	-50	+50
Temperature Menu		No variables	
Divert Menu (set in hrs/minutes)			
	Set Point	0 μS/cm	10,000 μS/cm
	Dead Band	5 μS/cm	500 μS/cm
	Divert Time Limit	1 minute	8 hrs:20 min (enabled) Unlimited (disabled)
4-20 mA Menus		4 & 20 mA Settings	0 μS/cm 10,000 μS/cm
Access Code Menu		New Value	0 9999
Alarm Menu*	High & Low (set to zero to disable)	1%	50%
Datalog Menu (Optional)		No variables	
Config Menu (Optional)		No variables	
Upgrade Menu		No variables	

*Note: The Alarm relay is non-programmable. Refer to the Main Menu diagram on page 16 for the list of error conditions that trigger the alarm relay.

3.0 UNPACKING & INSTALLATION

3.1 Unpacking the unit

Inspect the contents of the carton. Please notify the carrier immediately if there are any signs of damage to the controller or its parts. Contact your distributor if any of the parts are missing. The carton should contain: a WDC300 series monitor and an instruction manual. Any options or accessories will be incorporated as ordered.

3.2 Mounting the electronic enclosure

The WDC series monitor is supplied with mounting holes on the enclosure. It should be wall mounted with the display at eye level, on a vibration-free surface, utilizing all four mounting holes for maximum stability. Use M6 (1/4" diameter) fasteners that are appropriate for the substrate material of the wall. The enclosure is NEMA 4X rated. The maximum operating ambient temperature is 32 to 122°F (0 to 50°C); this should be considered if installation is in a high temperature location. The enclosure requires the following clearances:





Top:	2" (50 mm)
Left:	8" (203 mm)
Right:	4" (102 mm)
Bottom:	7" (178 mm)

3.3 Installation

The conductivity electrodes should be placed as close to the monitor as possible, to a maximum distance of 500 ft. Under 25 ft is recommended. Over 25 ft, the cable may need to be shielded from background electrical noise. (The standard cable length is 10 feet. Should you require longer cable, consult factory.)

Locate the electrode tees where an active sample of condensate water is available and where the electrode can easily be removed for cleaning. They must be situated so that the tee is always full and the electrode is never subjected to a drop in water level resulting in dryness. Refer to Figure 1 for typical installation.

3.4 Icon Definitions

Symbol	Publication	Description
	IEC 417, No.5019	Protective Conductor Terminal
	IEC 417, No. 5007	On (Supply)
	IEC 417, No. 5008	Off (Supply)
	ISO 3864, No. B.3.6	Caution, risk of electric shock
	ISO 3864, No. B.3.1	Caution

3.5 Electrical installation

The various standard wiring options are shown in Figure 2. Your WDC series monitor will arrive from the factory prewired or ready for hardwiring. Depending on your configuration of options, you may be required to hardwire some or all of the input/output devices. Refer to figures 3 and 4 for circuit board layout and wiring.



CAUTION



1. There are live circuits inside the monitor even when the power switch on the front panel is in the OFF position! The front panel must never be opened before power to the monitor is REMOVED!
If your monitor is prewired, it is supplied with a 8 foot, 18 AWG power cord with USA style plug. A tool (#1 Phillips driver) is required to open the front panel.
2. When mounting the monitor, make sure there is clear access to the disconnecting device!
3. The electrical installation of the monitor must be done by trained personnel only and conform to all applicable National, State and Local codes!
4. Proper grounding of this product is required. Any attempt to bypass the grounding will compromise the safety of persons and property.
5. Operating this product in a manner not specified by Walchem may impair the protection provided by the equipment.

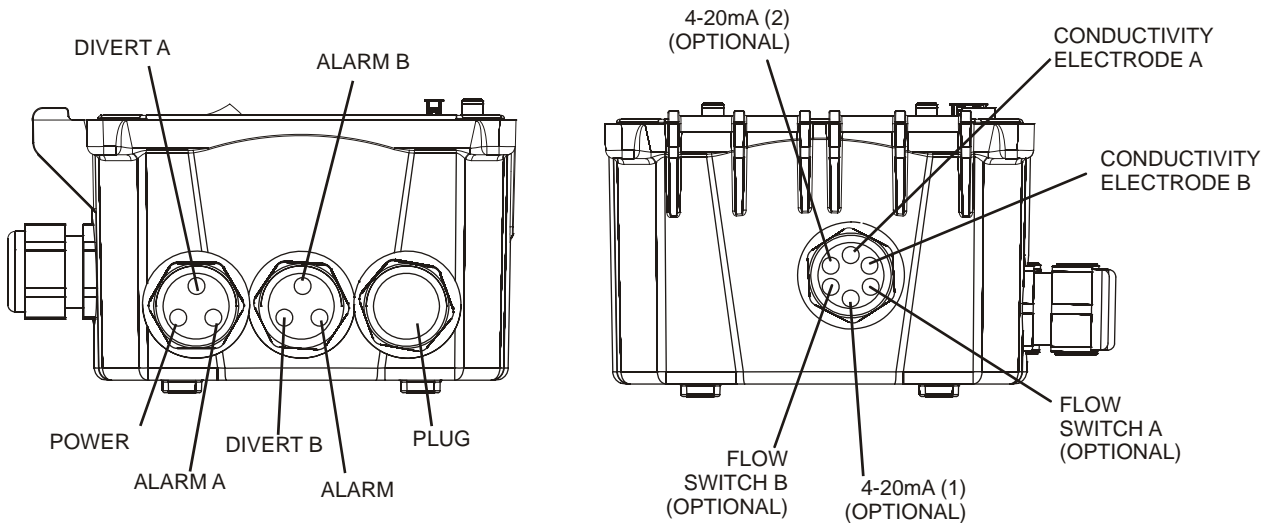

Figure 1 Conduit/Wiring Configuration

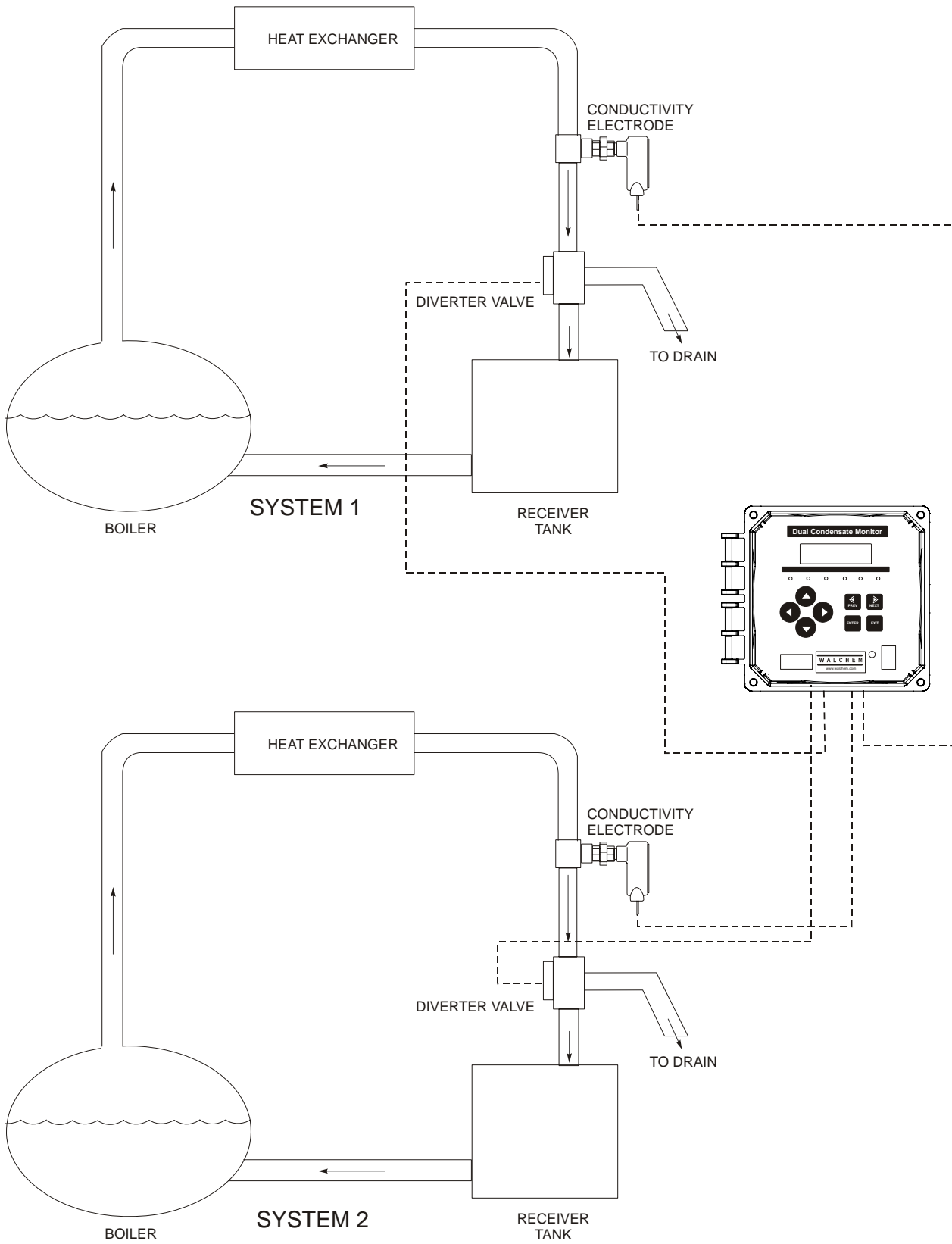

Figure 2 Typical Installation

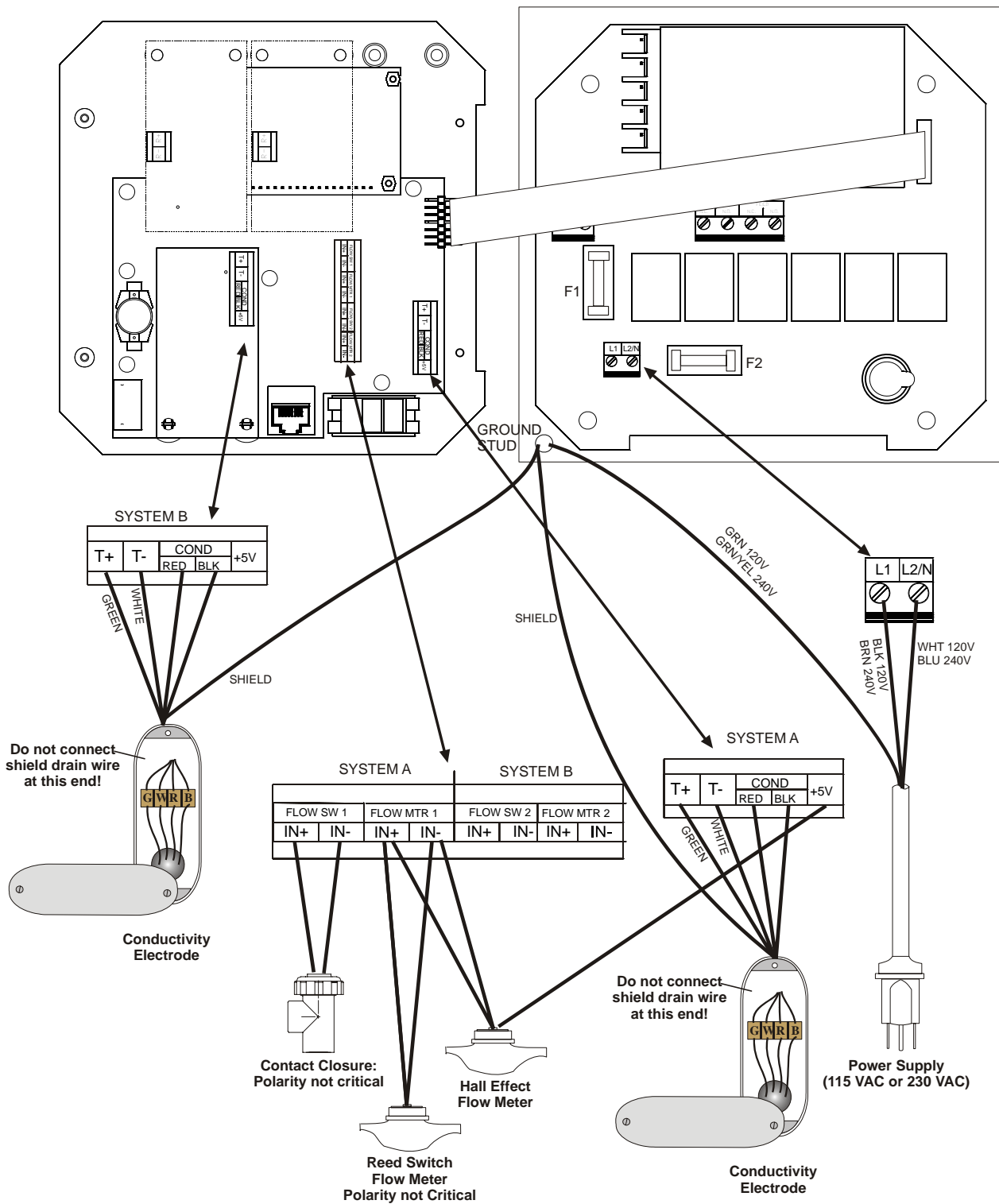

Figure 3 Inputs

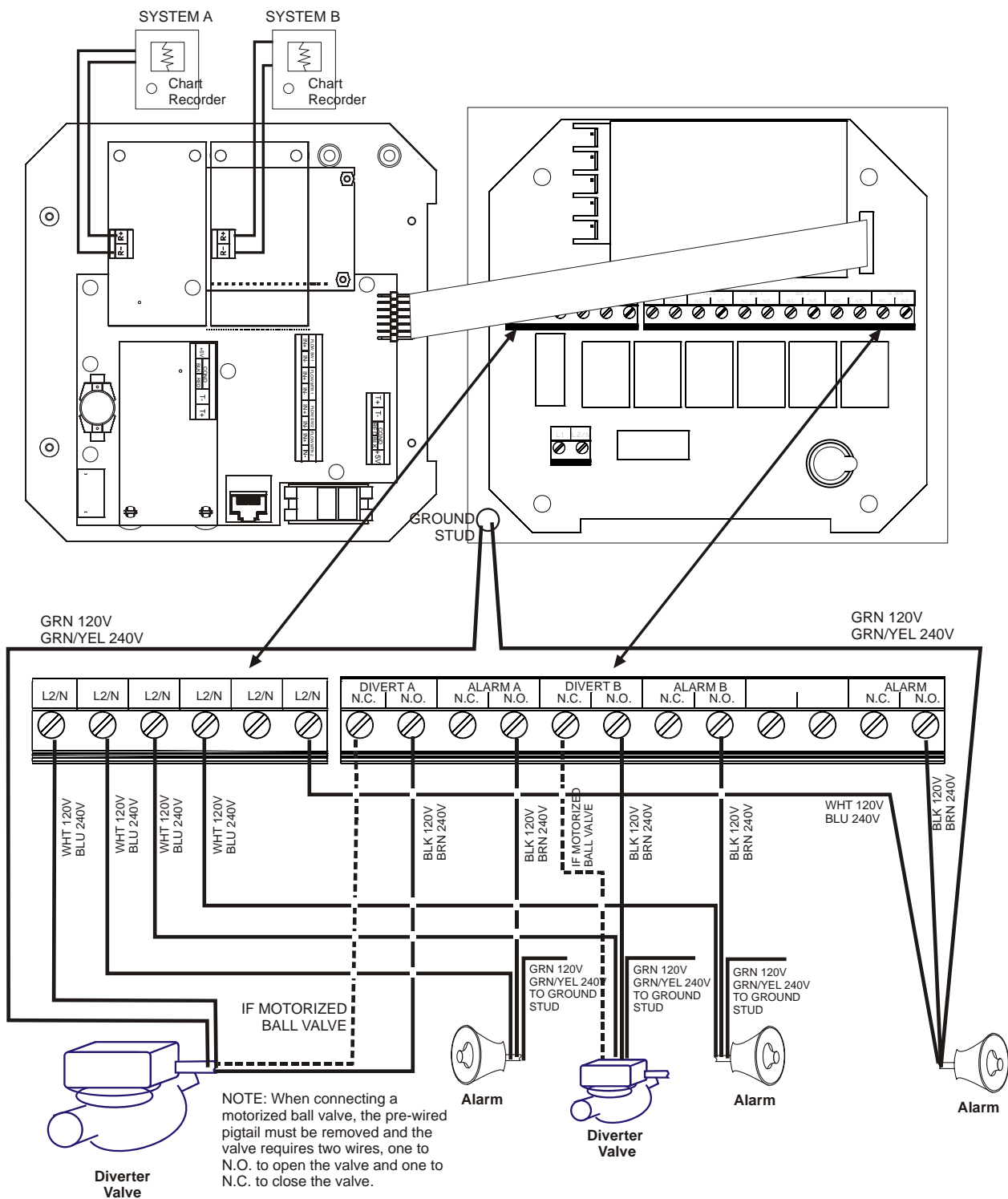

Figure 4 Outputs

4.0 FUNCTION OVERVIEW

4.1 Front Panel

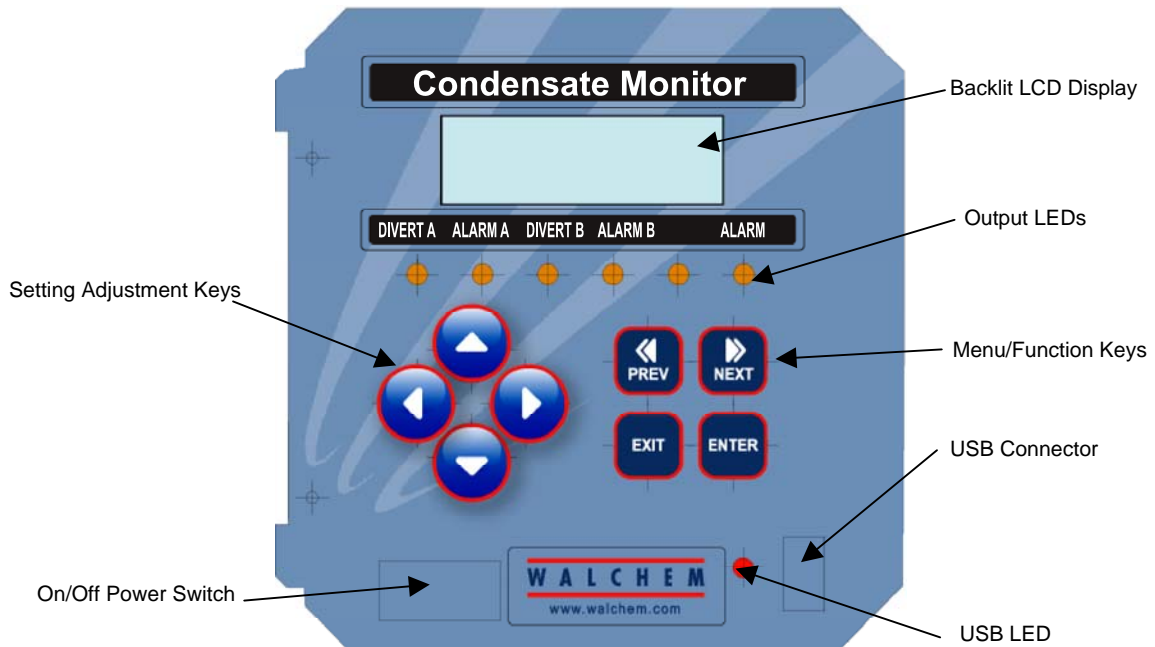

Figure 5 Front Panel

4.2 Display

A summary screen is displayed while the WDC monitor is on. This display shows the conductivity of the condensate from boiler A in one corner, the conductivity from boiler B in the other corner and current operating conditions. The operating conditions that may be displayed are Temp Error (Electrode A or B), Cond Error (Electrode A or B), Divert Timeout (A or B), Divert (A or B) and Normal. Normal just means there is nothing unusual to report.

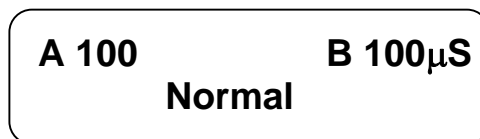
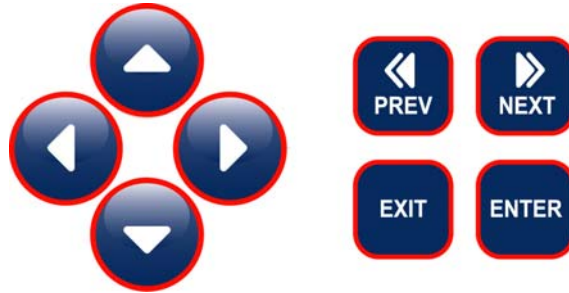

Figure 6 Summary Screen

4.3 Keypad

The keypad consists of 4 directional arrow keys and 4 function keys. The arrows are used to move the adjustment cursor and change settings, while the function keys are used to enter values, and navigate the various menu screens. The function keys are **ENTER**, **EXIT**, **NEXT**, and **PREV** (previous). **NEXT** and **PREV** scroll through the various menu choices. **ENTER** is used to enter a submenu and to enter a value. **EXIT** is used to back up one menu level. If you are at the main menu level, **EXIT** will return you to the Summary Display.



To change a value in a submenu, the left/right arrow keys move the cursor left and right to each digit or option that can be changed. The up/down arrows will change numeric values up or down, or scroll through option choices. Press **ENTER** only when you have finished making *all* of the changes for that menu screen.

4.4 Access Code

The WDC series monitor is shipped with the access code disabled. If you wish to enable it, see Section 5.6 for operation. With the access code enabled, any user can view parameter settings, but not change them. Note that this provides protection only against casual tampering. Use a lock on the cover latch if you need more protection.

4.5 Startup

Initial Startup

After having mounted the enclosure and wired the unit, the monitor is ready to be started.

Plug in the monitor and turn on the power switch to supply power to the unit. The display will briefly show the WDC model number and then revert to the normal summary display. Scroll through the menus and calibrate the conductivity reading, temperature, and set the control parameters detailed in Section 5, Operation.

To return to the summary display, press the **EXIT** key until you return to this screen. The controller will automatically return to this screen after 10 minutes.

Normal Startup

Startup is a simple process once your set points are in memory. Simply check your supply of chemicals, turn on the monitor, calibrate it if necessary and it will start controlling.

4.6 Shut Down

To shut the WDC monitor down, simply turn off the power. Programming remains in memory.

5.0 OPERATION

These units control continuously while power is applied. Programming is accomplished via the local keypad and display.

To view the top level menu, press any key. The menu structure is grouped by inputs and outputs. Each input has its own menu for calibration and unit selection as needed. Each output has its own setup menu including set points, timer values and operating modes as needed. After ten minutes of inactivity in the menu, the display will return to the summary display. Keep in mind that even while browsing through menus, the unit is still controlling.

5.1 Main Menu

The exact configuration of your WDC monitor determines which menus are available as you scroll through the settings. Certain menus are only available if you select certain options. All settings are grouped under the following main menu items: Boiler A, Boiler B and Access Code. Within the menu for each boiler, the following menus are found:

Main Menu Top Level

Boiler A	
Boiler B	
Time	
Access Code	
Datalog	Only if advanced USB feature is in model code
Config	Only if advanced USB feature is in model code
Upgrade	

Inside Boiler A and B menus

Conductivity A or B	
Temperature A or B	
Divert A or B	
4-20mA A or B	Only if 4-20mA option board(s) installed.

The **NEXT** key travels forward through this list while the **PREV** key travels backwards through the list. Pressing **ENTER** will Enter the lower level menu that is currently displayed.

Each of the following menu descriptions are used exactly the same way for either Boiler A or Boiler B.

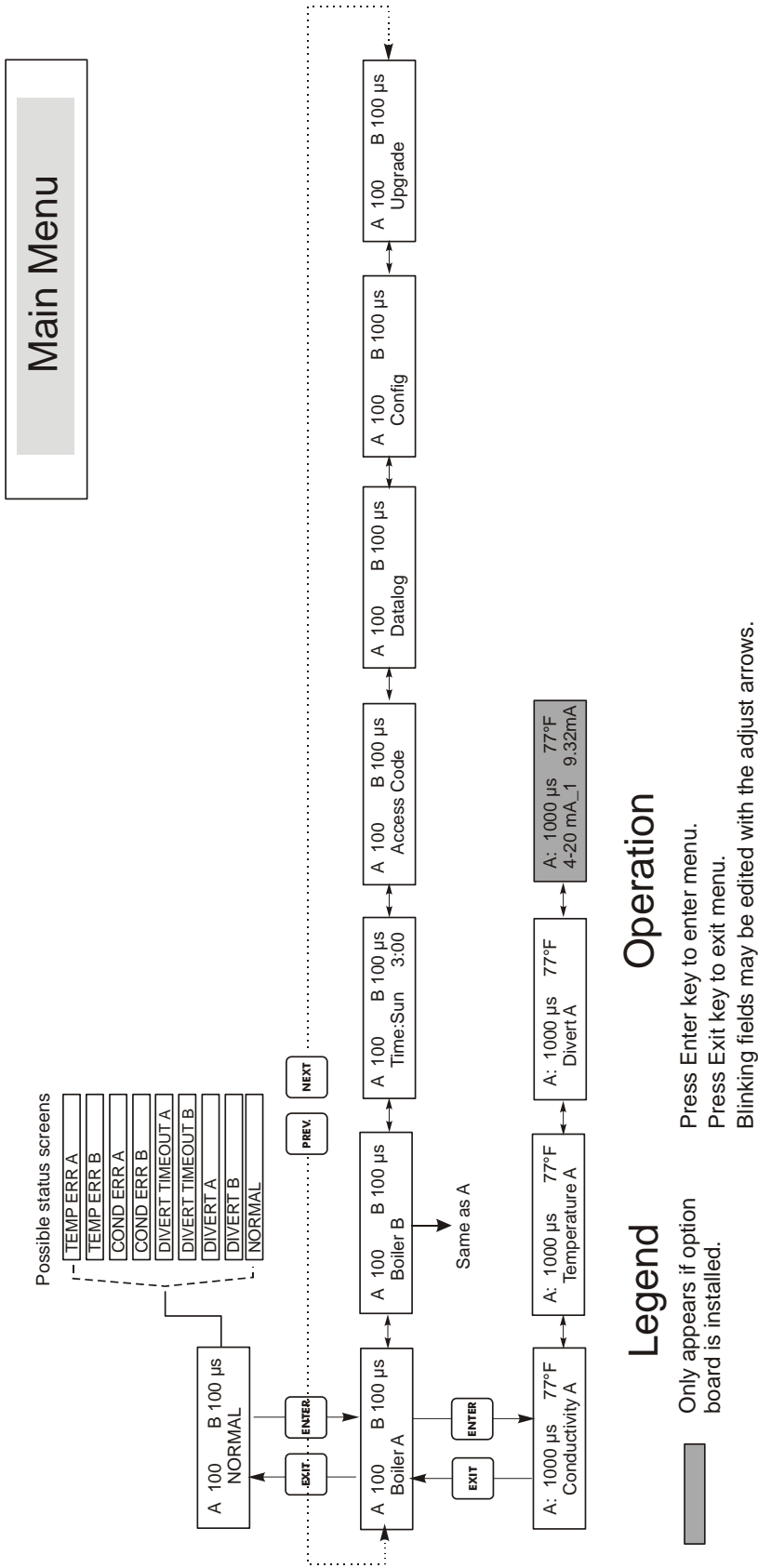
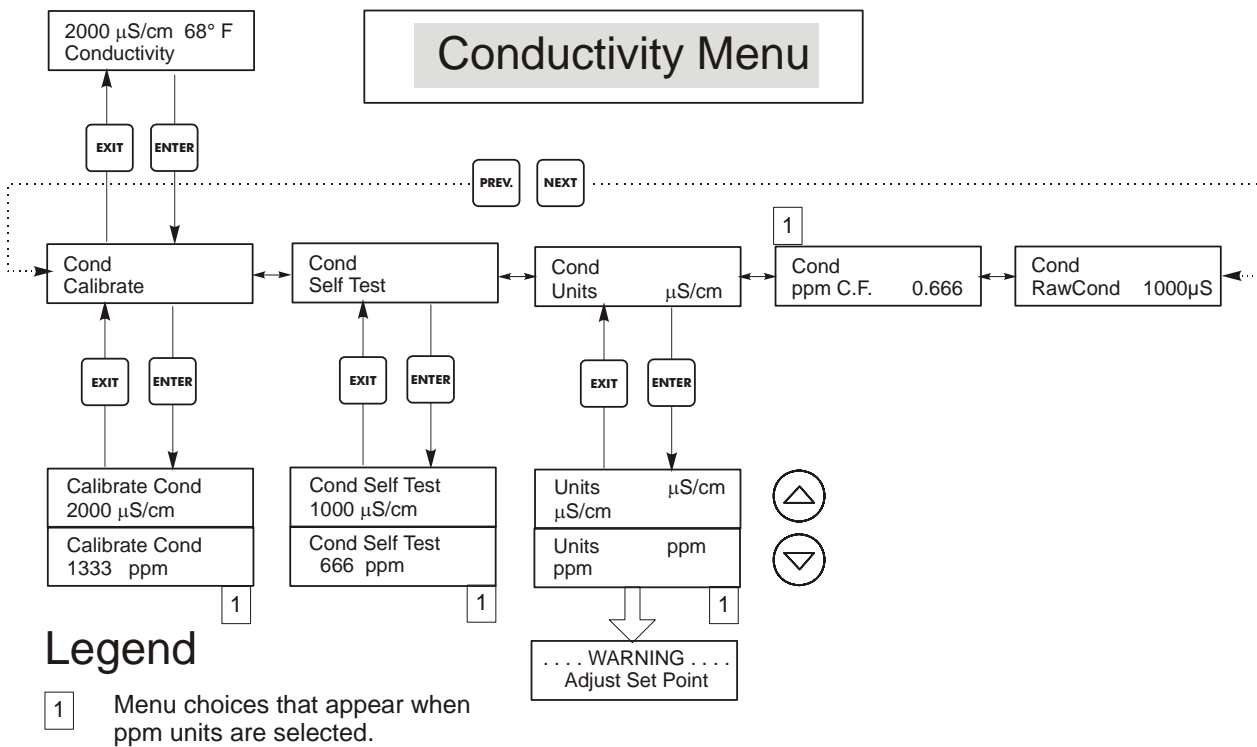

Figure 7 Main Menu

5.2 Conductivity (A or B) Menu

The conductivity menu provides the following settings: Calibration, Self Test, and Unit selection. Additional settings are also discussed below. Refer to figure 8, Conductivity Menu Chart.

Calibrate	To Calibrate the conductivity, use either a hand held meter, or a buffer solution, and adjust the WCM monitor to match. Once Calibrate is entered, the unit continuously displays conductivity readings. Press an arrow key to change the value displayed to match the hand held meter or the buffer solution. You must press ENTER to activate the new calibration. You must press the EXIT key to exit calibration.
Self Test	Press ENTER to begin self test. Press any key to stop. Self Test internally simulates a conductivity sensor and should <i>always</i> give the reading 1000 $\mu\text{S}/\text{cm} \pm 100 \mu\text{S}$. If it does not, there is a problem with the electronics and the unit should be serviced. If the self test is in the expected range and you have a problem calibrating, then the sensor or its wiring is at fault.
Units	You may choose to display conductivity in $\mu\text{S}/\text{cm}$ or in ppm. Press ENTER and then use the Up and Down arrows to change the units. If you change the units, you will be warned to check your settings. This is important. Set points are not automatically translated from $\mu\text{S}/\text{cm}$ to ppm. If you change the units you will need to change your Alarm settings.
ppm C.F.	This is the ppm Conversion Factor (or multiplier). This is typically 0.666 but can be changed to accommodate various requirements.
RawCond	This menu is for information only and displays the temperature-compensated conductivity reading before the user's calibration has been applied.



Operation

Press Enter key to enter menu.
 Press Exit key to exit menu.
 Blinking fields may be edited with the adjust arrows.
 Press Enter when modification is complete to return to Conductivity Menu Level.

Figure 8 Conductivity(A or B) Menu

5.3 Temperature (A or B) Menu

The Temperature menu provides the following settings: Calibration, Unit selection. The Temperature menu will be indicated on the display by one of the following:

- Temperature Normal operation
- Temp 70°F Normal operation
- Temp Error Indicates that there is a problem with the temperature input. See Figure 9.

Calibrate	This menu appears only if a temperature element is connected at power-up. To Calibrate the Temperature, use a thermometer to measure the fluid temperature and adjust the WDC monitor to match. Once Calibrate is entered, the unit continuously displays temperature readings. Press the Up or Down arrow key to change the value displayed to match the thermometer. You must press ENTER to activate the new calibration. You must press the EXIT key to exit calibration.
Man Temp	This menu appears only if no temperature element is connected at power-up. Use the arrow keys to adjust the temperature displayed to match that of the boiler water.
Units	You may choose to display temperature in °C or °F. Press ENTER and the Up or Down Arrow keys to change the temperature units for display.
Mode	Press ENTER and use the UP or DOWN arrow keys to select between Manual Temperature Compensation (used with sensors that do not have a temperature measuring element in them) or Automatic Temperature Compensation. If Automatic is selected, and the temperature element is not detected, the controller will display a Temp Error and revert to Manual Temp Comp until the signal is restored.

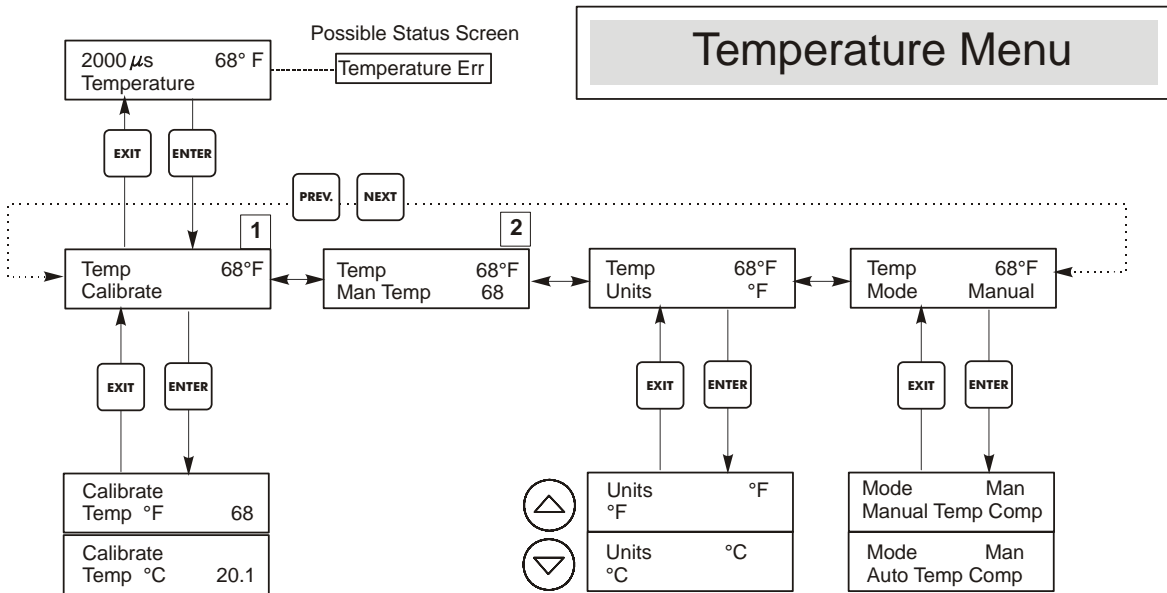

Legend

- 1 Menu wording that appears when Automatic Temperature Compensation is selected.
- 2 Menu wording that appears when Manual Temperature Compensation is selected.

Figure 9 Temperature (A or B) Menu

5.4 Divert (A or B) Menu

The Divert Menu provides the following settings: Set Point, Dead Band, Control Direction, HOA. The Divert menu will be indicated on the display by one of the following. The 'A' indicates that the output is being controlled automatically.

Divert A	OFF	Indicates that the divert output is currently OFF.
Divert A	10:00	Indicates the length of time that the Alarm output has been ON.
Divert A	TIMEOUT	Indicates that the direct output has been ON longer than the programmed time limit.

Set Point	This is the conductivity value at which the diverter valve output and alarm output are turned ON. The factory default setting for the WDC monitor is for the divert and alarm outputs to turn on when the conductivity is higher than the set point. This may be changed at the Control Direction screen.	
Dead Band	This is the conductivity value that when combined with the set point determines when the alarm outputs turn OFF. Assuming that the control direction is set for normal operation (High Set Point) the alarm outputs will turn off when the conductivity drops below the set point minus the Dead Band. For example: The set point is 25 $\mu\text{S}/\text{cm}$ and the Dead Band is 5 $\mu\text{S}/\text{cm}$. The alarm outputs turn ON when the conductivity reading is greater than 25 but does not turn OFF until the conductivity drops below 20.	
Time Limit	This menu allows you to set a maximum amount of time for the alarm. The limit time is programmed in hours and minutes and can be set between 1 minute and 8 hours, 59 minutes. If the time limit is set to zero, then the valve may be open indefinitely. If the maximum time is exceeded, the diverter valve will close and will not reopen until the "Reset Timer" menu is reset by an operator.	
Reset Timer	Only appears if the time limit above has been exceeded. Use the up or down arrow to change "N" to "Y", then press ENTER.	
Control Dir H / L	This allows you to set the Normal (High Set Point) or Inverse (Low Set Point) operation of the outputs. When set to High, the outputs turn on when the conductivity is <i>higher</i> than the set point. When set to Low, the outputs turn on when the conductivity is <i>lower</i> than the set point.	
	High Set Point	Low Set Point
H O A	The "Hand Off Auto" screen allows you to select the operating mode of the alarm outputs. In Hand (manual) mode, the output is turned on immediately for a maximum of 10 minutes. If you walk away, the output will return to Auto mode at the end of that time. In Off mode the output will stay Off indefinitely. In Auto mode the output will respond to changes in conductivity based on the set point. The HOA mode of the alarm output is indicated on the alarm status lines.	

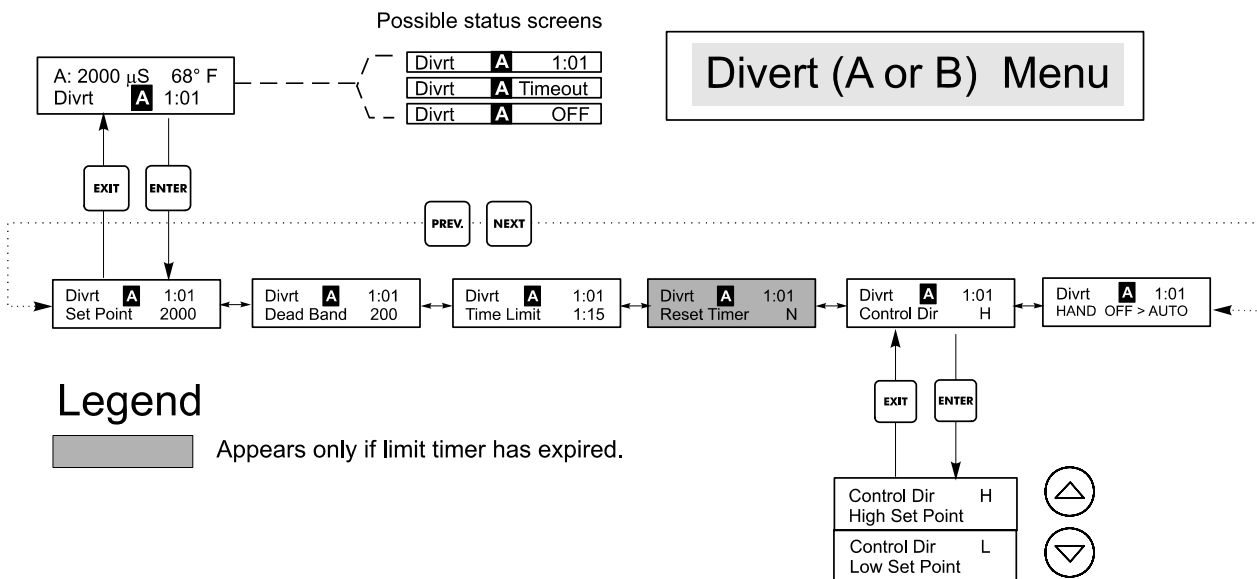

Figure 10 Divert (A or B) Menu

5.5 Time Menu

This menu has only one choice, to set the Time used for Datalogs. This menu will appear as follows:

Time: Mon 10:20

Set Time	Press ENTER to set the Time. Use the arrow keys to adjust the day and time and then press ENTER to store or EXIT to discard. If either biocide is set for a 2 or 4 week cycle, you can change the current week in the cycle by changing the week number. If the longest biocide cycle is 2 weeks, the 3Sun through 4Sat choices are not shown.
-----------------	--

Time Menu

Time Menu is only present if Biocide Option is installed.

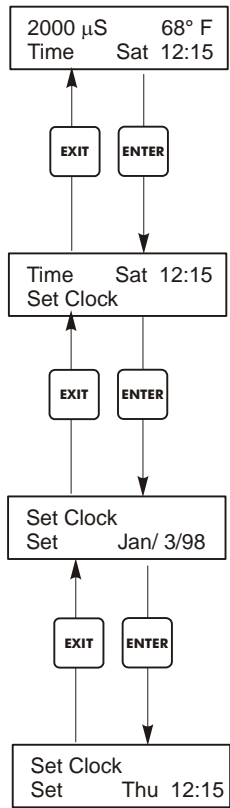

Figure 11 Time Menu

5.6 4-20mA (A or B) Menu

This menu is only available if the 4-20mA output board is installed in the controller. Installing this option board in the left hand position in the controller will assign it to Boiler A. Installing a 4-20mA option board in the right hand position assigns the output to Boiler B. See Figure 4.

This menu provides for scaling and calibrating the output. The 4-20mA menu screen appears as follows:

4-20mA 9.20mA

This indicates that the current output of the 4-20mA card is 9.20 mA.

Set 4mA Pt	This conductivity setting will correspond to a 4 mA output from the monitor.
Set 20mA Pt	This conductivity setting will correspond to a 20mA output from the monitor.
Calibrate	This will provide fixed 4mA and fixed 20mA outputs to allow you to calibrate connected equipment.

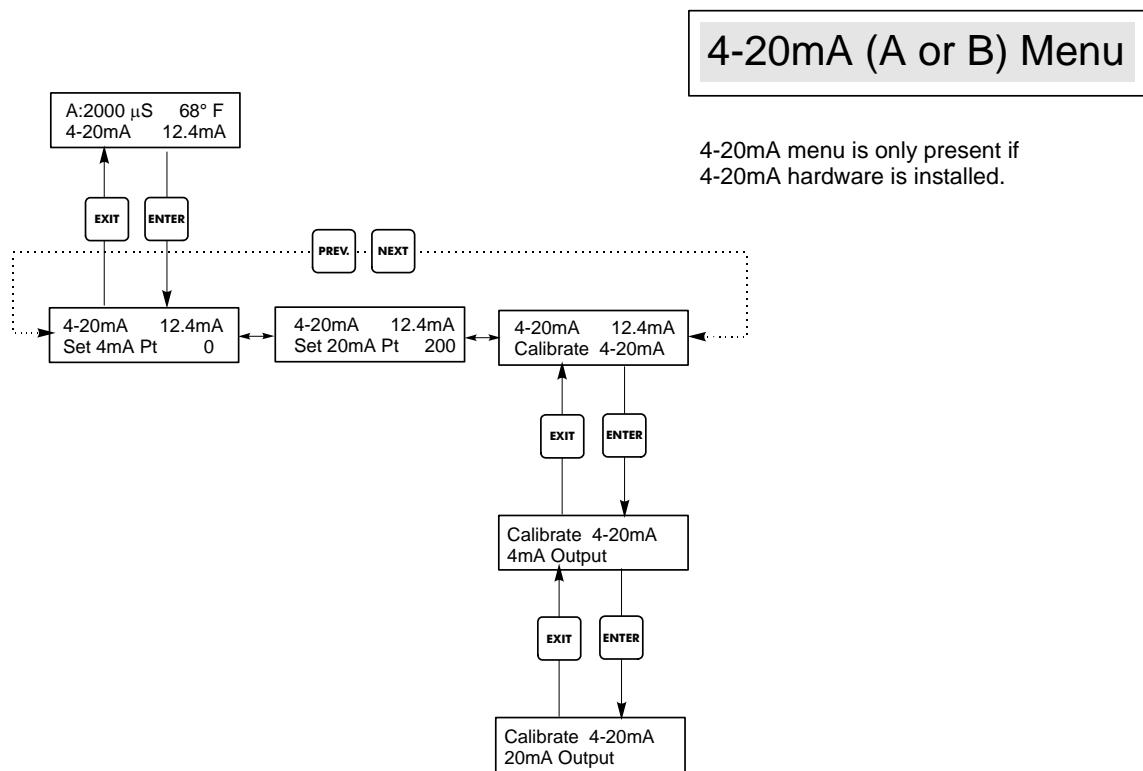

Figure 12 4-20mA (A or B) Menu

5.7 Access Code Menu

This menu determines whether the access code feature of the monitor is enabled or disabled and allows you to customize the access code to your own value. The access code controls whether or not you are allowed to change the parameters in the monitor. With the access code disabled, any user may change any parameter. With the access code enabled, any user can view any parameter, but cannot change them. Once an attempt is made to change a parameter, the display will prompt the user to enter the access code. If the correct access code is entered, the parameters can be changed. If the wrong access code is entered the parameters cannot be changed. Once the access code has been correctly entered, it will remain valid until there is a period of 10 minutes without a key being pressed. The access code menu will appear as shown below:

The access code menu will appear as shown below:

Access Code	DIS	Indicates that the access code is disabled. No access code is required to change any setting.
Access Code	REQ	Indicates that the access code is required to alter settings.
Access Code	OK	Indicates that the access code is required and has been entered correctly.

Enable N / Y	Press the Up or Down arrow key to change the N to Y and press ENTER to enable the access code feature. If the access code is enabled you must first enter the access code to disable it.
New Value	<p>Press ENTER to display the current access code value and use the arrow keys to change it to any value between 0 and 9999. If the access code has been enabled, you will be prompted to enter the current access code before being allowed to change it. You must remember the access code if you enable it.</p> <p>The Factory default Access code is 1995.</p> <p>If you change the access code and can't remember it follow this procedure:</p> <ol style="list-style-type: none"> 1. Turn off power to the monitor. 2. Wait 10 seconds. 3. Press and Hold the UP and DOWN arrow keys while turning on the power. 4. Read the access code on the display. 5. Release the keys, and the access code will disappear.

Access Code Menu

Any Top Display
Access Code 0000

The Access Code prompt may appear at any screen in the entire menu structure if the current access code has not been entered by the user. Access code entries will be valid for 10 minutes from the most recent key press.

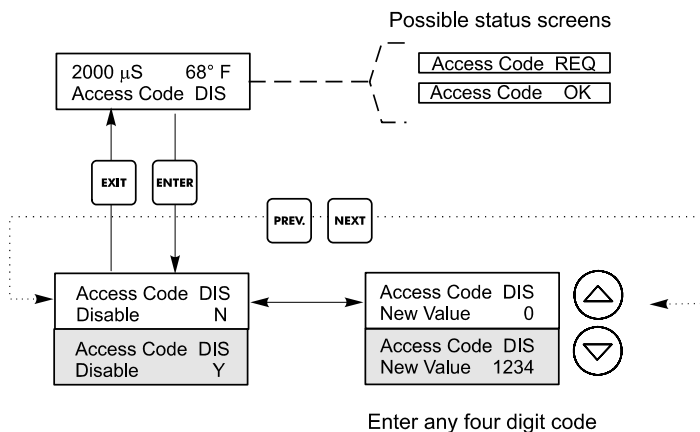

Figure 13 Access Code Menu

5.8 Datalog Menu

This menu is available if the data logging option has been purchased. This is indicated in the model code by the letter U at the end of the model code. This menu allows you to save data from the controller to a USB flash drive.

The controller has four logs, the Current Datalog, the Backup Datalog, the Event Log, and the Reset Log. All files are in a CSV format that may be opened in a spreadsheet such as Microsoft Excel.

Current Datalog Contains the following data taken at 10 minute intervals:

Conductivity
Temperature

When the current datalog is downloaded to a USB stick, it is erased and a new log file is started.

If the current datalog is not downloaded before it reaches its maximum size (at least 60 days of data) the oldest data is overwritten by the newest data.

Backup Datalog Contains the same data as the current log but it is never erased. When the backup log reaches its maximum size (at least 60 days of data), the oldest data is overwritten by the newest data.

Event Log Contains columns for each relay and flow switch input, as well as the date and time. Each time any of these change state, the date and time is updated and it will show a 1 if the relay is on and 0 if it is off, and a 1 if the flow switch indicates no flow, 0 if there is flow. Tens of thousands of events will be recorded before the oldest data is overwritten by the newest, the number varying with the controller's configuration.

Reset Log Consists of time stamps of when power was lost, when it was returned, and the cause of the reset.

Current or Backup Datalog	<p>Place a USB flash drive with at least 10 MB capacity into the USB port on the front panel of the controller. Press the Enter key to download the file from the controller to the disk. The file name for the Current Datalog will be Datalog<serial number><date><time>.csv using the date and time it was downloaded. The file name for the Backup Datalog will be Datalog<serial number><date><time>.csv using the date and time it was created.</p> <p>The controller will display the progress of the file download process. If the file was successfully copied to the USB disk the controller will display Transfer Success.</p>	
Copy Event Log	<p>Place a USB flash drive with at least 10 MB capacity into the USB port on the front panel of the controller. Press the Enter key to download the file from the controller to the stick. The file name will be Eventlog<serial number><date><time>.csv.</p> <p>The controller will display the progress of the file download process. If the file was successfully copied to the USB disk the controller will display Transfer Success, otherwise Transfer Fail 1.</p>	
	Transfer Success	Transfer Fail 1
Copy Reset Log	<p>Place a USB flash drive with at least 10 MB capacity into the USB port on the front panel of the controller. Press the Enter key to download the file from the controller to the stick. The file name will be Resetlog<serial number><date><time>.csv.</p> <p>The controller will display the progress of the file download process. If the file was successfully copied to the USB disk the controller will display Transfer Success.</p>	
	Transfer Success	Transfer Fail 1

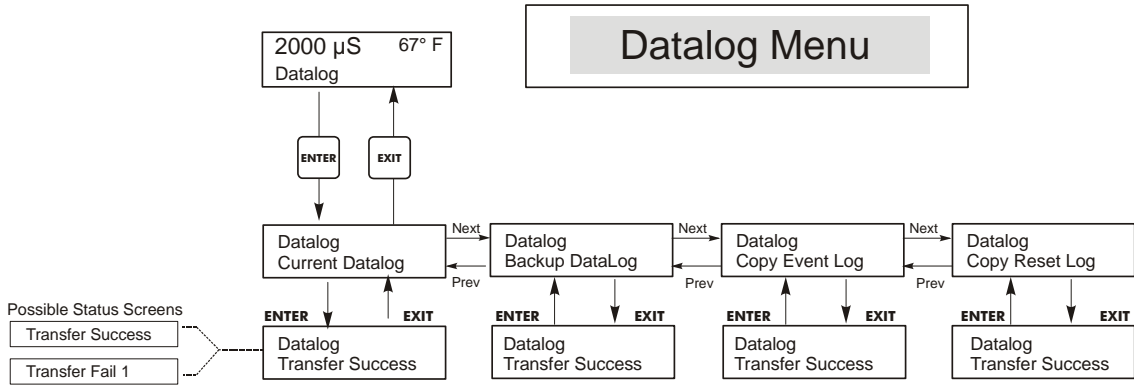

Figure 14 Datalog Menu

5.9 Config Menu

This menu allows you to export a file that contains all of the set points in the monitor to a USB flash disk drive, and then later import the set points into another monitor.

Export Config	Place a USB flash drive with at least 10 MB capacity into the USB port on the front panel of the monitor. Press the Enter key to export the configuration file from the monitor to the stick. The file name will be UCF.ini. If you are exporting files with different set points you may rename the file to something that describes it, as long as it has an ini extension.	
	The monitor will display the progress of the file download process. If the file was successfully exported to the USB disk the monitor will display Transfer Success, otherwise Transfer Fail 1.	
	Transfer Success	Transfer Fail 1
Import Config	Place a USB flash drive that contains only one configuration file stored on the root directory of the stick into the USB port on the front panel of the monitor. Press the Enter key to import the configuration file from the stick to the monitor. The file name must have an ini extension in its name.	
	The monitor will display the progress of the file import process. If the file was successfully imported from the USB disk the monitor will display one of the messages below:	
	Import Failure	Indicates that there were problems connecting to or accessing the USB stick.
	Import Success: Any key to reboot	The configuration file import succeeded and will be ready for use after reboot.
	File Open Failed	A config file could not be found on the USB stick or the USB stick file system could not be accessed.
	File Read Failed	The config file is too short (incomplete) or empty.
	Invalid CFG File	The imported file is not a valid config file.
	Invalid Model	The imported config file is not for this monitor model.
	Wrong SW Version	The version of the imported config file is not compatible with this monitor software version.
	Corrupt CFG File	The imported config file is corrupt. (The checksum failed.)
Wrong file Size	The size of the imported config file is wrong.	

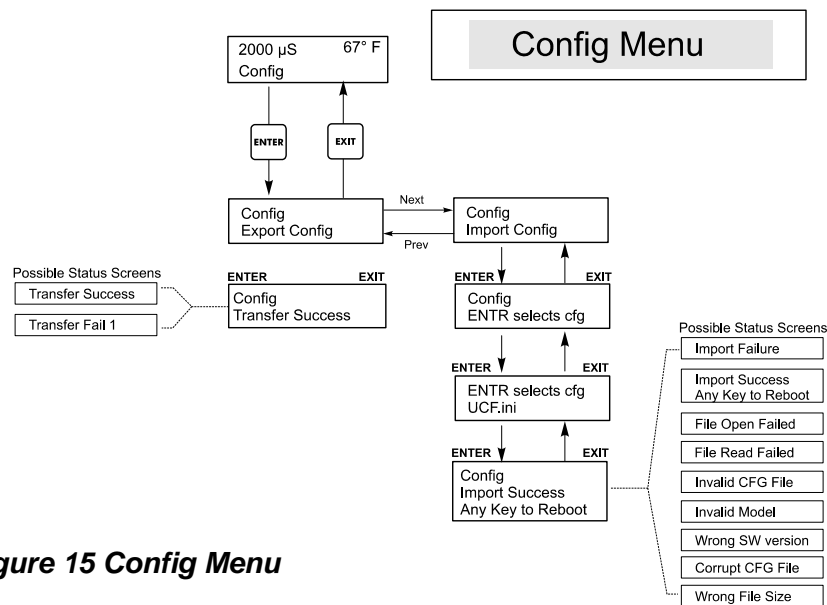

Figure 15 Config Menu

5.10 Upgrade Menu

This menu is used to upgrade the software to a newer version. If a new version of the software is available, an upgrade file will be posted on our web site. Save this file to a USB flash disk drive. It needs to be the only executable (.exe file extension) file stored on the root directory of the stick. Press the Enter key to import the software upgrade file from the stick to the monitor.

The monitor will display the progress of the file import process. If the file was successfully imported from the USB disk the monitor will display Transfer Success. The monitor will automatically reboot and come up with the new software installed.

Upgrade	The monitor will display the progress of the file import process. If the file was successfully imported from the USB disk the monitor will display Transfer Success. The monitor will automatically reboot and come up with the new software installed.	
	If the software upgrade fails, you will see one of the following messages:	
	UpgradFileInvald	The file found on the USB stick is for the wrong product, or is corrupt. Try getting the correct upgrade file and make sure it's the only upgrade file on the stick.
	No Upgrade File	There is no upgrade file stored on the stick, or the file is named incorrectly.
	CorrptUpgradFile	Try getting a new copy of the file.
	Flash Failure	The flash memory on the processor board has a problem. Repair or replace the front panel assembly.

To check that it was successful, turn off power to the monitor, then press the Enter key while turning power on. The monitor will show the software version, which should match the name of the upgrade file that you used.

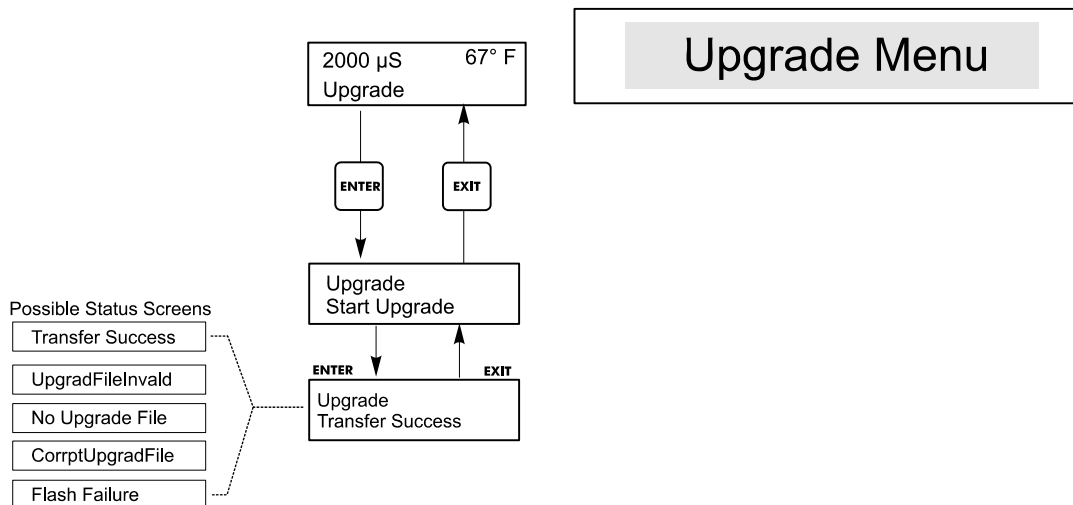

Figure 16 Upgrade Menu

6.0 MAINTENANCE

The WDC monitor itself requires very little maintenance. Wipe with a damp cloth. Do not spray down the monitor unless the enclosure door is closed and latched.

6.1 Electrode Cleaning

NOTE: The monitor must be recalibrated after cleaning the electrodes.

Frequency

The electrodes should be cleaned periodically. The frequency required will vary by installation. In a new installation, it is recommended that the electrodes be cleaned after two weeks of service. To determine how often the electrodes must be cleaned, follow the procedure below.

1. Read and record the conductivity.
2. Remove, clean and replace the conductivity electrodes in the process.
3. Read conductivity and compare with the reading in step 1 above.

If the variance in readings is greater than 5%, increase the frequency of electrode cleaning. If there is less than 5% change in the reading, the electrodes were not dirty and can be cleaned less often.

Cleaning Procedure

The electrodes can normally be cleaned using a cloth or paper towel and a mild cleaning solution such as 409® cleanser. Occasionally an electrode may become coated with various substances which require a more vigorous cleaning procedure, such as immersion in dilute muriatic acid. Usually the coating will be visible, but not always.

6.2 Replacing the Fuses



CAUTION: Disconnect power to the monitor before opening front panel!

Locate the fuses on the circuit board at the back of the monitor enclosure. (See figure 3.) Gently remove the old fuse from its retaining clip and discard. Press the new fuse into the clip, secure the front panel of the monitor and return power to the unit.

Warning: Use of non-approved fuses can affect product safety approvals. Fuse ratings depend on controller power rating. Specifications are shown below. To insure product safety certifications are maintained, it is recommended that a Walchem fuse be used.

F1 Fuse	Walchem P/N	F2 Fuse	Walchem P/N
5 x 20 mm, 1.0A, 250V	103163	5 x 20 mm, 6A, 250V	102834

7.0 TROUBLESHOOTING



CAUTION: Disconnect power to the monitor before opening front panel!

Troubleshooting and repair of a malfunctioning monitor should only be attempted by qualified personnel using caution to ensure safety and limit unnecessary further damage. Contact the factory.

7.1 Error Messages

TEMP ERROR	
This error condition indicates that the temperature signal from the conductivity electrode is no longer valid. The controller will revert to manual temperature compensation.	
Possible Cause	Corrective Action
Green or White electrode wire disconnected.	Reconnect.
Faulty electrode	Replace electrode. Revert to manual temperature compensation by cycling power off and on.
COND ERROR	
This error condition will stop conductivity control. It indicates that the conductivity signal from the electrode is no longer valid. This prevents controlling based upon a bogus conductivity reading.	
Possible Cause	Corrective Action
Black or red electrode wire shorted	Disconnect short.
Faulty electrode	Replace electrode.
Faulty controller	Verify via failed self test.
COND HIGH ALARM	
This error message indicates that the conductivity is above the programmed percentage above set point. The conductivity will continue to be monitored, and the divert and feed outputs will be allowed to be activated.	
Possible Cause	Corrective Action
Fouled conductivity electrode	See Conductivity Electrode Troubleshooting section.
Divert flow rate too low	Check for clogged strainer. Check for insufficient pressure differential.
Divert valve not opening	Check for faulty divert valve. Check divert valve wiring. Check controller relay.
Conductivity rose over alarm limit while biocide lockout occurred	Allow normal divert to occur.
COND LOW ALARM	
This error message indicates that the conductivity is below the programmed percentage below set point. The conductivity will continue to be monitored, and the feed output will be allowed to be activated.	
Possible Cause	Corrective Action
Fouled conductivity electrode	See Conductivity Electrode Troubleshooting section.
Electrode disconnected	Reconnect.
Electrode dry	See "No Flow" Troubleshooting section
Divert valve stuck open	Check for faulty divert valve. Check divert valve wiring. Check controller relay.
Biocide prebleed set too low	Change prebleed set point to be above low alarm if desired.

7.2 Conductivity Readout Does Not Change

<i>If the readout is stuck at or near zero:</i>	
Possible Cause	Corrective Action
Dry electrode	Check for flow through system.
Electrode is disconnected.	Check wiring to electrode. Go to self-test menu, as described in section 5.2. If readout changes to 900-1100, the problem is with electrode or connections. See section 7.2. If still at zero, problem is with controller. Consult the factory.
Electrode is coated.	Clean off non-conductive coating with a suitable solvent.
<i>If the readout is stuck at another number:</i>	
Possible Cause	Corrective Action
Dirty or faulty electrode	Evaluate electrode (section 7.2).
Stagnant sample	Check system for proper flow.

7.3 Procedure for Evaluation of Conductivity Electrode

Can be used for troubleshooting a sensor error message, low conductivity, high conductivity, conductivity stuck at 0, cal failure, and/or conductivity stuck at a number other than 0.

Try cleaning the electrode first (refer to Sect. 6.1).

To find out if the electrode or the controller is faulty, step through the Self-Test menu, as described in section 5.2. The display should read $1000 \pm 100 \mu\text{S}/\text{cm}$. This indicates that the controller is OK and the problem is in the electrode or its connections. If it does not read $1000 \pm 100 \mu\text{S}/\text{cm}$, return the control module for repair.

To check the electrode, check the electrode connections to the terminal strip (refer to Figure 3). Make sure that the correct colors go to the correct terminals, and that the connections are tight. Restore power and see if the conductivity is back to normal. If not, replace the electrode.

7.4 Procedure for checking relay outputs

If any prewired output is not activating the device (pump, valve, etc.) attached to it:

Verify that the pump or valve is not faulty by plugging it directly into a wall socket.

In some controllers, certain relays are NOT internally powered. Check the instruction manual to determine if the relay is a dry contact type. If so, make sure that external power (115 VAC) has been connected to the relay. In most cases, this will be a jumper wire from the large screw labeled "HOT" to one of the relay terminals.

Manually activate the relay using the hand-off-auto menu. Verify that the LED on the front panel lights up. If the device turns on, there must be a problem with the set points if the device doesn't turn on when it should.

With power removed, check the wiring of the pigtail to the terminal strips. Make sure that they are not loose, that they are not connected by the wire's jacket, and that they are connected to the

correct terminal. Also check the removable terminal block where the black (hot) wires attach (TB2) to see if it has pulled loose. Restore power and manually activate the relay.

With power removed, remove the terminal block that has the black (hot) wires from all of the pigtails (TB2). This simply pulls up off some metal pins. Check these pins for corrosion. If they seem coated with anything, scrape off the coating by replacing and removing the terminal block several times. Restore power and manually activate the relay.

With power removed, remove the TB2 terminal block again, and attach one lead of a multimeter to the pin that lines up with the wire for the relay in question, and the other lead on the other side of the relay (this will be an adjacent pin for a dry contact relay, or neutral at TB3 for a powered relay). Set the meter to read resistance. Restore power and verify that the meter reads infinite ohms with the relay off (open) and very low ohms with the relay on (closed). If it always reads infinite ohms, the controller is faulty.

8.0 SERVICE POLICY

The WDC series Condensate Monitor has a 2-year warranty on electronic components and a 1-year warranty on mechanical parts (keypad, terminal strip and relays).

We stock circuit boards for immediate exchange after we have isolated the cause of the problem.

Factory authorized repairs that are received by next-day-air will be returned within 24 hours. Normal priority for returns is two weeks.

Out of warranty repairs or circuit board exchanges are done on a flat fee basis after the warranty is expired.

FIVE BOYNTON ROAD
TEL: 508-429-1110

HOPPING BROOK PARK
FAX: 508-429-7433

HOLLISTON, MA 01746 USA
Web: www.walchem.com