

SureCross DX99 FlexPower RTD Node (Metal Housing)



Datasheet

The SureCross® wireless system is a radio frequency network with integrated I/O that can operate in most environments and eliminate the need for wiring runs. DX99 wireless networks are formed around a Gateway, which acts as the wireless network master device, and one or more Intrinsically Safe Nodes.



For additional information, updated documentation, and accessories, refer to Banner Engineering's website, www.bannerengineering.com/surecross.

- Wireless industrial I/O device with up to four 3-wire Pt100 RTDs; other types are available with configuration
- FlexPower® technology driven by one lithium primary battery integrated into the housing
- DIP switches for user configuration
- Frequency Hopping Spread Spectrum (FHSS) technology and Time Division Multiple Access (TDMA) control architecture ensure reliable data delivery within the unlicensed Industrial, Scientific, and Medical (ISM) band
- Transceivers provide bidirectional communication between the Gateway and Node, including fully acknowledged data transmission
- Lost RF links are detected and relevant outputs set to user-defined conditions
- DX99 Metal housings are certified for use in Class I, Division 1, Groups A, B, C, D; Class II, Division 1, Groups E, F, G; Class III, Division 1; and Zone 0 (Category 1G) and Zone 20 (Category 1D) when properly installed in accordance with the National Electrical Code, the Canadian Electrical Code, or applicable local codes/regulations

Models	Frequency	I/O
DX99N9X1S0N0R4X0D0	900 MHz ISM Band	Inputs: Four 3-wire RTDs
DX99N2X1S0N0R4X0D0	2.4 GHz ISM Band	

Internal antenna models are also available. For more information, contact your local Banner Engineering Corp. representative. Integrated battery models are also available without batteries. If you purchase a model without the battery, Banner Engineering recommends using the XENO XL-205F battery or equivalent. For DX99 models, only a XENO XL-205F battery is certified.



WARNING: Not To Be Used for Personnel Protection

Never use this device as a sensing device for personnel protection. Doing so could lead to serious injury or death. This device does not include the self-checking redundant circuitry necessary to allow its use in personnel safety applications. A sensor failure or malfunction can cause either an energized or de-energized sensor output condition.

SureCross User Configuration Tool

The User Configuration Tool (UCT) software runs on any Windows machine and uses a converter cable to connect your Gateway to the computer.



The User Configuration Tool (UCT) offers an easy way to link I/O points in your wireless network, view I/O register values graphically, and set system communication parameters when a host system is not part of the wireless network. Download the most recent revisions of the UCT software from Banner Engineering's website: <http://www.bannerengineering.com/wireless>.

The UCT requires a special USB to RS-485 (model number BWA-UCT-900 for 1 Watt radios, BWA-HW-006 can be used for all other radios) converter cable to pass information between your computer and the Gateway.



Setting Up Your Wireless Network

To set up and install your wireless network, follow these steps.

Disconnect the power from your SureCross devices.

1. Configure the DIP switches of all devices.
2. Connect the sensors to the SureCross devices.
3. Apply power to all devices.
 - For two LED models, the Gateway's LED 1 is solid green and the Node's LED 2 flashes red to indicate there is no radio link to the Gateway.
 - For one LED models, the Gateway's LED is solid green and the Node's LED flashes red to indicate there is no radio link to the Gateway.
4. Form the wireless network by binding the Nodes to the Gateway. If the binding instructions are not included in the datasheet, refer to the product manual for binding instructions.
5. Observe the LED behavior to verify the devices are communicating with each other.
 - For two LED models, the Gateway's LED 1 is solid green and the Node's LED 1 flashes green to indicate it is communicating with the Gateway.
 - For one LED models, the Gateway's LED is solid green and the Node's LED flashes green to indicate it is communicating with the Gateway.
6. Conduct a site survey between the Gateway and Nodes. If the site survey instructions are not included in this datasheet, refer to the product manual for detailed site survey instructions.
7. Install your wireless sensor network components. If installation instructions are not included in this datasheet, refer to the product manual for detailed installation instructions.

For additional information, including installation and setup, weatherproofing, device menu maps, troubleshooting, and a list of accessories, refer to one of the following product manuals.

- SureCross Wireless I/O Network Instruction Manual: [132607](#)
- Web Configurator Instruction Manual (used with "Pro" and DX83 models): [134421](#)
- Host Controller Systems Instruction Manual: [132114](#)

Configure the DIP Switches

Before making any changes to the DIP switch positions, disconnect the power. DIP switch changes will not be recognized if power isn't cycled to the device. For devices with batteries integrated into the housing, remove the battery for at least one minute.

Accessing the DIP Switches (Metal Housing)

The DIP switches are located behind the rotary dials. Mount the radio cover back onto the pins attached to the screw terminal board.

To access the DIP switches, follow these steps:

1. Unscrew and remove the top of the DX99 metal housing. The top section is the section with the glass window.
2. Pull the radio cover section off the screw terminal board base. The radio cover is held to the screw terminal board using two pins.

DIP Switch Settings (RTD)

Switches								
Device Settings	1	2	3	4	5	6	7	8
Rotary dial address mode	OFF*							
Extended address mode	ON							
Modbus or UCT configured (overrides DIP switches)		OFF*						
DIP switch configured		ON						
Temp °Fahrenheit			OFF*					
Temp °Celsius			ON					
High resolution (0.1 degree) **				OFF*				
Low resolution (1 degree)				ON				

Switches								
Device Settings	1	2	3	4	5	6	7	8
Platinum, 100 ohm (European, DIN 43760)					OFF*	OFF*	OFF*	
Copper, 10 ohm (alpha = 0.00427)					OFF	ON	OFF	

* Default configuration

** In high resolution mode, the temperature = (Modbus register value) ÷ 20. In low resolution mode, the temperature is (Modbus register value) ÷ 2.

Address Mode

The SureCross wireless devices may use one of two types of addressing modes: rotary dial addressing or extended addressing. In rotary dial address mode, the left rotary dial establishes the network ID and the right rotary dial sets the device ID. The wireless network is restricted to a maximum of 16 devices.

Extended address mode uses a security code to "bind" Nodes to a specific Gateway. Bound Nodes can only send and receive information from the Gateway to which they are bound. In extended address mode, wireless networks may contain up to 48 radio devices. For more information on extended address mode, refer to the SureCross™ Wireless I/O Network product manual.

The device ships in rotary dial address mode by default, with the DIP switch in the OFF position. To use extended address mode, change the DIP switch to the ON position.

Modbus/User Configuration Tool (UCT) or DIP Switch Configured

In Modbus/UCT Configured mode, the device parameters are changed using the User Configuration Tool (UCT) or a Modbus command. All DIP switch positions are ignored. In DIP Switch Configured mode, use the DIP switches to configure the parameters listed in the table.

RTD Type

Use DIP switches 5, 6, and 7 to select the RTD type. The default position is the OFF position for all switches, setting the RTD to a Platinum 100 ohm type.

Supported RTD Types

The RTD Node supports up to four 3-wire RTD inputs by default. Additional types are available with configuration.

RTDs	Range °F	Range °C
Pt100 (DIN 0.00385)	-328 to 900 °F	-200 to 482 °C
Cu 10 Ohm (alpha = 0.00427) ¹	-328 to 500 °F	-200 to 260 °C

Temperature Resolution

When set to high resolution, temperature values are stored to the nearest tenth (0.1) of a degree (default position). To measure temperatures above 1600 degrees Fahrenheit or 1600 degrees Celsius, switch the DIP switch to the ON position and use low resolution mode. In high resolution, the device cannot store values larger than 1600.

Temperature Units

Use the DIP switch to specify if the temperature is stored in degrees Fahrenheit or Celsius. The default position is OFF, setting the temperature to Fahrenheit. For Celsius measurements, set this switch to the ON position.

Terminal Blocks and Wiring

Wiring Diagrams. For CSA C/US and LCIE/ATEX approved wiring procedures and to check the Entity Parameters (Safety Parameters), refer to the complete control drawing, document [141513](#) at www.bannerengineering.com.

¹ For the copper RTD, the best accuracy is when measuring between -50 to +150 °C (-58 to +302 °F). Below this range, expect errors approaching 3% of reading. Above this range, expect errors approaching 0.5% of reading.

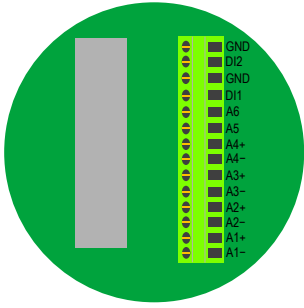

Ax+ and Ax-. Analog IN x. Analog inputs for devices requiring more than one connection, such as thermocouples or RTDs. When there is no Ax-, use Ax+ as an analog input.

DIx. Discrete IN x

GND. Ground/dc common connection

The GND connection can be considered the same as the housing ground when using a stainless steel antenna feedthrough (model BWA-HW-016 or BWA-HW-017). When the stainless steel antenna feedthroughs are not used, the GND connection is isolated from the metal housing.

LED Behavior for the Nodes

Nodes do not sample inputs until they are communicating with the Gateway. The radios and antennas must be a minimum distance apart to function properly. Recommended minimum distances are:

- 2.4 GHz 65 mW radios: 1 foot
- 900 MHz 150 mW radios: 6 feet
- 900 MHz 1 Watt radios: 15 feet

LED 1	LED 2	Node Status
Flashing green		Radio Link Ok
Flashing red	Flashing red	Device Error
	Flashing red, 1 per 3 sec	No Radio Link

Storage Mode and Sleep Mode

While in storage mode, the radio does not operate. All SureCross® radios powered from an integrated battery ship from the factory in storage mode to conserve the battery. To wake the device, press and hold button 1 for 5 seconds. To put any FlexPower® or integrated battery SureCross radio into storage mode, press and hold button 1 for 5 seconds. The radio is in storage mode when the LEDs stop blinking, but in some models, the LCD remains on for an additional minute after the radio enters storage mode. After a device has entered storage mode, you must wait 1 minute before waking it.

During normal operation, the SureCross radio devices enter sleep mode after 15 minutes of operation. The radio continues to function, but the LCD goes blank. To wake the device, press any button.

Modbus Register Table (RTD High Resolution Mode)

I/O	Modbus Holding Register		I/O Type	Units	I/O Range		Holding Register Representation (Dec)		Terminal Block Labels
	Gateway	Any Node			Min.	Max.	Min.	Max.	
1	1	1 + (Node# × 16)							
2	2	2 + (Node# × 16)							
3	3	3 + (Node# × 16)	RTD 1	°F/°C	-1638.3	+1638.4	-32768	32767	A1+/A1-/A5-
4	4	4 + (Node# × 16)	RTD 2	°F/°C	-1638.3	+1638.4	-32768	32767	A2+/A2-/A6-
5	5	5 + (Node# × 16)	RTD 3	°F/°C	-1638.3	+1638.4	-32768	32767	A3+/A3-/DI1
6	6	6 + (Node# × 16)	RTD 4	°F/°C	-1638.3	+1638.4	-32768	32767	A4+/A4-/DI2
7	7	7 + (Node# × 16)	Reserved						
8	8	8 + (Node# × 16)	Device Message						

I/O	Modbus Holding Register		I/O Type	Units	I/O Range		Holding Register Representation (Dec)		Terminal Block Labels
	Gateway	Any Node			Min.	Max.	Min.	Max.	
		...							
15	15	15 + (Node# × 16)	Control Message						
16	16	16 + (Node# × 16)	Reserved						

In high resolution mode, the temperature = (Modbus register value) ÷ 20. In low resolution mode, the temperature is (Modbus register value) ÷ 2.

Temperature values are stored as signed values in the Modbus register. A 0 in the register is interpreted as 0°; and 65535 in the register (0xFFFF) is interpreted as -1 ÷ 20 = -0.05° in high resolution mode and -1 ÷ 2 = -0.5° in low resolution mode.

Assembly

Follow these steps to assemble your DX99...D Single Chamber Metal Housing model.



The DX99 unit ships as a complete unit, including the radio core, housing, and integrated battery. A small bag containing a black flexible antenna extension cable and one terminal header is also included in the shipment.

(For internal antenna models, the flexible antenna extension cable is not included.)



To unpack and wire the unit:

1. Open the end with the glass window and gently lift the radio core and the space frame it sits on up. The core unit connects to the space frame using two pins and the radio is connected to the wiring board with a ribbon cable.
2. Disconnect the ribbon cable from the radio.



3. Insert the battery into the battery holder, verifying the position and negative poles of the battery are positioned according to the markings on the board.

4. Insert your sensor wires through a cable gland and one of the two 1/2" NPT ports. Wire the sensor wires into the terminal header according to the control drawings, p/n 141513.

Use a cable gland certified for your region and environment. For a waterproof seal, refer to the waterproofing instructions in Banner document 132607.

5. Install the terminal header onto the terminal pins.

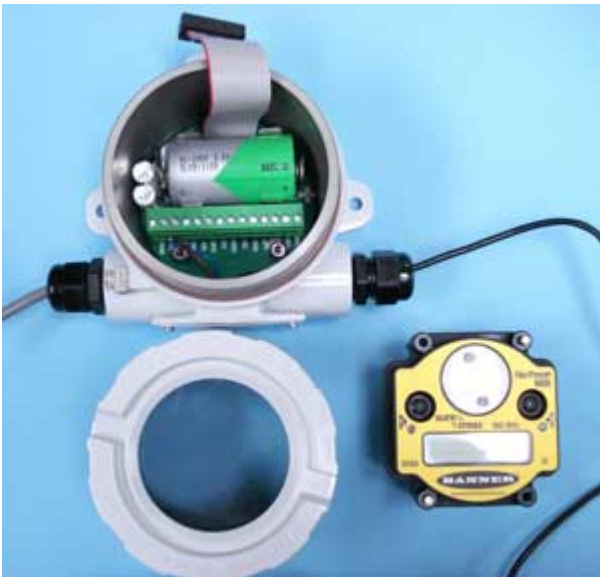

6. Thread your antenna cable through a cable gland and into the other 1/2" NPT port. Use a cable gland certified for your region and environment. For a waterproof seal, refer to the waterproofing instructions in Banner document 132607. (Not applicable for internal antenna models.)

When using the stainless steel antenna feedthrough (not shown, sold separately), thread the antenna cable through the port and thread the stainless steel antenna feedthrough into the port. For a waterproof seal, refer to the waterproofing instructions in Banner document 132607.



7. Connect the end of your antenna cable to the supplied flexible antenna extension cable or to the antenna connector on the stainless steel antenna feedthrough. (The supplied flexible antenna extension cable remains inside the DX99 housing.)

8. Attach the flexible antenna extension or antenna feedthrough cable to the radio unit's antenna connector. (You may need to separate the space frame from the radio to do this.) This step is not applicable for internal antenna models.

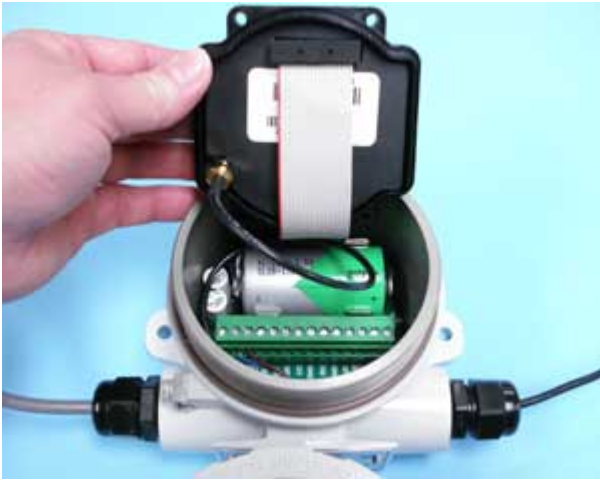

9. Gently install the ribbon cable into the ribbon cable pins, verifying the ribbon cable is seated on both rows of pins.



10. Reconnect the space frame to the radio core unit.

11. Place the radio unit into the housing and gently push down until the spacer frame pin holes rest on the edge of the metal housing.



12. Close the metal cover firmly and lock closed using the set screw.

Replacing the Battery (DX99...D Models)

To replace the lithium "D" cell battery in the metal housings, follow these steps.

1. Unscrew the lid of the metal enclosure.
2. Disconnect the radio by unplugging the ribbon cable from the radio board.
The radio board is mounted inside the metal lid.
3. Remove the discharged battery by pressing the battery towards the negative terminal to compress the spring. Pry up on the battery's positive end to remove from the battery holder.
4. Replace with a new battery. Only use a 3.6 V lithium battery from Xeno, model number XL-205F.
5. Verify the battery's positive and negative terminals align to the positive and negative terminals of the battery holder mounted within the case. Caution: There is a risk of explosion if the battery is replaced incorrectly.
6. Wait two minutes.
7. Plug the ribbon cable back into the radio board.
8. Screw on the lid and tighten.
9. After replacing the battery, allow up to 60 seconds for the device to power up.
10. Properly dispose of your used battery according to local regulations by taking it to a hazardous waste collection site, an e-waste disposal center, or other facility qualified to accept lithium batteries.



As with all batteries, these are a fire, explosion, and severe burn hazard. Do not burn or expose them to high temperatures. Do not recharge, crush, disassemble, or expose the contents to water.

The battery may be replaced in explosive gas atmospheres. Replacement battery model number: BWA-BATT-001. For pricing and availability, contact Banner Engineering.

Battery Replacement Warnings



WARNING:

- Do not replace battery when an explosive dust atmosphere may be present.
- The replacement battery **MUST** be a Banner approved battery, model number BWA-BATT-001. Use of a different battery will **VOID** the intrinsic safety rating of this device and may result in an explosion!
- When replacing the battery, the negative end of the battery holder is the side with the spring terminal. This side is marked with a minus (–) sign.
- Do not attempt to recharge the battery. These batteries are not rechargeable. Recharging may cause serious injury to personnel or damage the equipment. Replace only with factory recommended batteries.

Specifications

Radio Range²

900 MHz, 150 mW: Up to 4.8 km (3 miles)
2.4 GHz, 65 mW: Up to 3.2 km (2 miles)

Minimum Separation Distance

900 MHz (150 mW): 2 m (6 ft)
2.4 GHz (65 mW): 0.3 m (1 ft)

Transmit Power

900 MHz, 150 mW: 21 dBm (150 mW) conducted
2.4 GHz, 65 mW: 18 dBm (65 mW) conducted, less than or equal to 20 dBm (100 mW) EIRP

900 MHz Compliance (150 mW)

FCC ID TGUDX80 - This device complies with FCC Part 15, Subpart C, 15.247
IC: 7044A-DX8009

2.4 GHz Compliance

FCC ID UE300DX80-2400 - This device complies with FCC Part 15, Subpart C, 15.247
ETSI/EN: In accordance with EN 300 328: V1.7.1 (2006-05)
IC: 7044A-DX8024

Spread Spectrum Technology

FHSS (Frequency Hopping Spread Spectrum)

Antenna Connection

Ext. Reverse Polarity SMA, 50 Ohms
Max Tightening Torque: 0.45 N·m (4 lbf·in)

RTD Inputs

Sample Rate: 1 second
Report Rate: 16 seconds
Accuracy: 0.1% of full scale
Resolution: 0.1 °C, 15-bit

Supply Voltage

3.6 V dc low power option from an internal battery

Power Consumption

Consumption: Application dependant

Housing

Glass and cast aluminium w/ chromating and chemically resistant paint (outside only)

Link Timeout

Gateway: Configurable via User Configuration Tool (UCT) software
Node: Defined by Gateway

Interface

Indicators: Two bi-color LEDs
Buttons: Two
Display: Six character LCD

Wiring Access

Two 1/2-inch NPT ports, one 3/4-inch NPT port (internal threads)

Environmental Ratings³

IEC IP68

Operating Conditions⁴

-40 °C to +65 °C (-40 °F to +149 °F) (Electronics); -20 °C to +80 °C (-4 °F to +176 °F) (LCD)
95% maximum relative humidity (non-condensing)
Radiated Immunity: 10 V/m, 80-2700 MHz (EN61000-6-2)

Shock and Vibration

IEC 68-2-6 and IEC 68-2-27
Shock: 30g, 11 millisecond half sine wave, 18 shocks
Vibration: 0.5 mm p-p, 10 to 60 Hz

Certifications



CSA: Class I, Division 1, Groups A, B, C, D; Class II, Division 1, Groups E, F, G; Class III, Division 1 (Ex ia IIC T4 / AEx ia IIC T4)
Certificate: 2008243



LCIE/ATEX: Zone 0 (Category 1G) and 20 (Category 1D),
Temperature Class T4 (II 1 GD / Ex ia IIC T4 / Ex iaD 20 IP68 T82°C)
Certificate: LCIE 08 ATEX 6098 X

Special Conditions for Safe Use imposed by Intrinsic Safety Certificate LCIE 08 ATEX 6098 X: Ambient temperature range is -40 to 70 °C. SureCross® DX99 FlexPower devices can only be connected to Intrinsically Safe certified equipment or simple apparatus as defined by EN 60079-11. All connected equipment must comply with the Entity Parameters (Safety Parameters) listed in the [Control Drawings](#) (p/n 141513). The device must only use a lithium battery manufactured by XENO, type XL-205F.



² Radio range is with the 2 dB antenna that ships with the product. High-gain antennas are available, but the range depends on the environment and line of sight. To determine the range of your wireless network, perform a Site Survey.

³ Refer to the [SureCross Wireless I/O Networks Instruction Manual](#) (p/n 132607) for installation and waterproofing instructions.

⁴ Operating the devices at the maximum operating conditions for extended periods can shorten the life of the device.

Metal Housing Dimensions

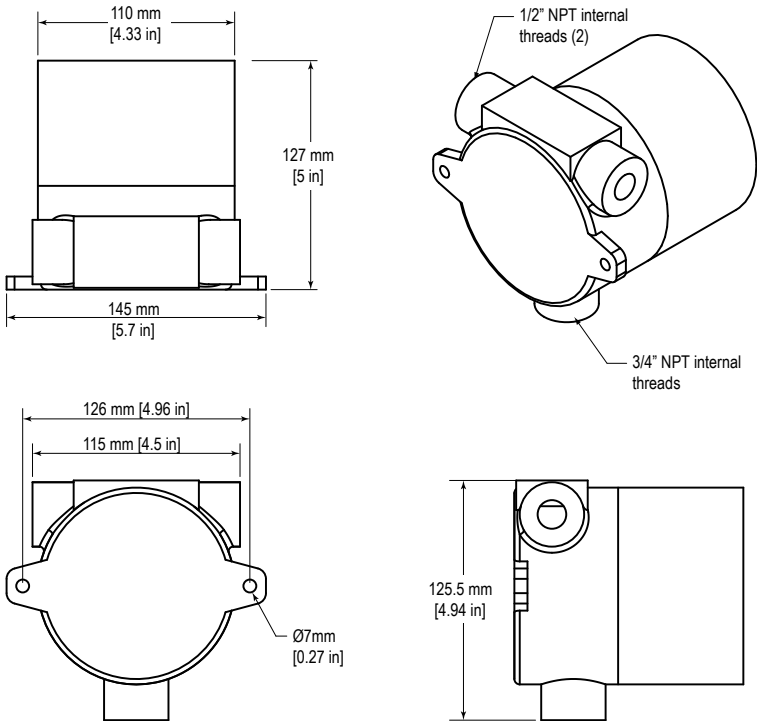



Included with Device (Metal Housing)

The following items ship with the metal housings.

- BWA-902-C (900 MHz) or BWA-202-C (2.4 GHz): Antenna, 2 dBd Omni, Rubber Swivel RP-SMA Male. (Not included with Internal antenna models)
- BWA-HW-025: Cable pack, Flexible antenna cable, terminal strip

Metal Housing Accessories

Model No.	Description	List Price	
BWA-HW-016	Antenna Feedthrough, Stainless Steel, 1/2" NPT	\$62	
BWA-HW-017	Antenna Feedthrough, Stainless Steel, 3/4" NPT	\$66	
BWA-HW-012	DX99 Antenna Extension Pack (M4-0.7 × 20 black steel pan head screw, flexible antenna cable 12" SMA male to SMA female)	\$42	
BWA-HW-037	Clear plastic retaining ring for DX99 metal housings (10 pack)	\$20	
BWA-AXFS0130	AXF™ Explosion-Proof Antenna Coupler		

Omni-Directional Dome Antennas					
Models	Frequency	Description	Connection	List Price	
BWA-902-001	900 MHz	2 dBi, 18-inch cable	1/2" SS NPT Port	\$140	
BWA-902-002		2 dBi, 18-inch cable	3/4" SS NPT Port	\$140	
BWA-202-001	2.4 GHz	2 dBi, 18-inch cable	1/2" SS NPT Port	\$140	
BWA-202-002		2 dBi, 18-inch cable	3/4" SS NPT Port	\$140	

Warnings

Antenna Installations. Install and properly ground a qualified surge suppressor when installing a remote antenna system. Remote antenna configurations installed without surge suppressors invalidate the manufacturer's warranty. Keep the ground wire as short as possible and make all ground connections to a single-point ground system to ensure no ground loops are created. No surge suppressor can absorb all lightning strikes; do not touch the SureCross® device or any equipment connected to the SureCross device during a thunderstorm.

Exporting SureCross Radios. It is our intent to fully comply with all national and regional regulations regarding radio frequency emissions. Customers who want to re-export this product to a country other than that to which it was sold must ensure the device is approved in the destination country. A list of approved countries appears in the *Radio Certifications* section of the product manual. The SureCross wireless products were certified for use in these countries using the antenna that ships with the product. When using other antennas, verify you are not exceeding the transmit power levels allowed by local governing agencies. Consult with Banner Engineering Corp. if the destination country is not on this list.

Violating Warnings. The manufacturer does not take responsibility for the violation of any warning listed in this document. Make no modifications to this product; any modifications to this product not expressly approved by Banner Engineering could void the user's authority to operate the product. All specifications published in this document are subject to change; Banner reserves the right to modify product specifications or update documentation at any time. For the most recent version of any documentation, refer to: www.bannerengineering.com. © 2006-2014 Banner Engineering Corp. All rights reserved.

Banner Engineering Corp. Limited Warranty

Banner Engineering Corp. warrants its products to be free from defects in material and workmanship for one year following the date of shipment. Banner Engineering Corp. will repair or replace, free of charge, any product of its manufacture which, at the time it is returned to the factory, is found to have been defective during the warranty period. This warranty does not cover damage or liability for misuse, abuse, or the improper application or installation of the Banner product.

THIS LIMITED WARRANTY IS EXCLUSIVE AND IN LIEU OF ALL OTHER WARRANTIES WHETHER EXPRESS OR IMPLIED (INCLUDING, WITHOUT LIMITATION, ANY WARRANTY OF MERCHANTABILITY OR FITNESS FOR A PARTICULAR PURPOSE), AND WHETHER ARISING UNDER COURSE OF PERFORMANCE, COURSE OF DEALING OR TRADE USAGE.

This Warranty is exclusive and limited to repair or, at the discretion of Banner Engineering Corp., replacement. IN NO EVENT SHALL BANNER ENGINEERING CORP. BE LIABLE TO BUYER OR ANY OTHER PERSON OR ENTITY FOR ANY EXTRA COSTS, EXPENSES, LOSSES, LOSS OF PROFITS, OR ANY INCIDENTAL, CONSEQUENTIAL OR SPECIAL DAMAGES RESULTING FROM ANY PRODUCT DEFECT OR FROM THE USE OR INABILITY TO USE THE PRODUCT, WHETHER ARISING IN CONTRACT OR WARRANTY, STATUTE, TORT, STRICT LIABILITY, NEGLIGENCE, OR OTHERWISE.

Banner Engineering Corp. reserves the right to change, modify or improve the design of the product without assuming any obligations or liabilities relating to any product previously manufactured by Banner Engineering Corp.