

## Datasheet



Sure Cross® MultiHop embeddable board devices were specifically designed for the needs of industrial users to provide connectivity where traditional wired connections are not possible or cost prohibitive.

- Wireless industrial module with two PNP discrete inputs, two PNP discrete outputs, two 0 to 20 mA analog inputs, and two 0 to 20 mA analog outputs
- Selectable transmit power levels of 250 mW or 1 Watt for 900 MHz models and 65 mW for 2.4 GHz models
- 10 to 30 V dc power input
- Self-healing, auto-routing RF network with multiple hops extends the network's range
- Serial and I/O communication on a Modbus platform
- Message routing improves link performance
- DIP switches select operational modes: master, repeater, or slave
- FHSS radios operate and synchronize automatically

For additional information, updated documentation, and accessories, refer to Banner Engineering's website, [www.bannerengineering.com/surecross](http://www.bannerengineering.com/surecross).

Models	Antenna Connection	Frequency	I/O
DX80DR9M-HB2	Ext. Reverse Polarity SMA, 50 Ohms	900 MHz ISM Band	I nputs: Two PNP discrete, two 0 to 20 mA analog
DX80DR2M-HB2		2.4 GHz ISM Band	
DX80DR9MU-HB2	U.FL-R-SMT.(01)	900 MHz ISM Band	O utputs: Two PNP discrete, two 0 to 20 mA analog
DX80DR2MU-HB2		2.4 GHz ISM Band	



### WARNING: Not To Be Used for Personnel Protection

Never use this device as a sensing device for personnel protection. Doing so could lead to serious injury or death. This device does not include the self-checking redundant circuitry necessary to allow its use in personnel safety applications. A sensor failure or malfunction can cause either an energized or de-energized sensor output condition.



### CAUTION: Electrostatic Discharge (ESD)

ESD Sensitive Device. Use proper handling procedures to prevent ESD damage to these devices. The module does not contain any specific ESD protection beyond the structures contained in its integrated circuits. Proper handling procedures should include leaving devices in their anti-static packaging until ready for use; wearing anti-static wrist straps; and assembling units on a grounded, static-dissipative surface.



### CAUTION: Never Operate 1 Watt Radios Without Antennas

To avoid damaging the radio circuitry, never power up Sure Cross® Performance or Sure Cross MultiHop (1 Watt) radios without an antenna.



## MultiHop Configuration Tool

Use Banner's MultiHop Configuration Tool software to view your MultiHop radio network and configure the radio and its I/O.

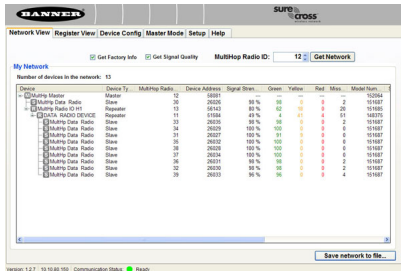

The MultiHop Configuration Tool requires that you connect your master radio to your computer using either a USB to RS-485 (for RS-485 radios) or a USB to RS-232 (for RS-232 radios) converter cable. For RS-485 models, Banner recommends using cable model BWA-UCT-900, an RS-485 to USB adapter cable with a wall plug that can power your 1 Watt MultiHop radio while you are configuring it.

If you use an adapter cable that does not also supply 10-30V dc to your radio, use the DIP switches to set the MultiHop Radio to transmit at 250 mW.

When the MultiHop Configuration Tool launches, it automatically checks to see if a newer version of the software is available. If a newer version is available, a dialog box displays on the screen to ask you if you want to download the new version or ignore the new version. If you select download, the newer version automatically downloads, installs, and relaunches the program for you.

## Setting Up Your MultiHop Network

To set up and install your wireless MultiHop network, follow these steps:

1. If your radios have DIP switches, configure the DIP switches of all devices.
2. Connect the sensors to the MultiHop radios if applicable.
3. Apply power to all devices.
4. If your MultiHop radio has rotary dials, set the MultiHop Radio (Slave) ID. If your MultiHop radio has no rotary dials, continue to the next step.
5. Form the wireless network by binding the slave and repeater radios to the master radio. If the binding instructions are not included in this datasheet, refer to the quick start guide or product manual.
6. Observe the LED behavior to verify the devices are communicating with each other.
7. Conduct a site survey between the MultiHop radios. If the site survey instructions are not included in this datasheet, refer to the product manual.
8. Install your wireless sensor network components. If the installation instructions are not included in this datasheet, refer to the product manual.

For additional information, including installation and setup, weatherproofing, device menu maps, troubleshooting, and a list of accessories, refer to one of the following product manuals:

- MultiHop Radio Quick Start Guide: [152653](#)
- MultiHop Radio Product Manual: [151317](#)
- MultiHop Register Guide (End User Edition): [155289](#)

## Configure the DIP Switches

Before making any changes to the DIP switch positions, disconnect the power. DIP switch changes will not be recognized if power isn't cycled to the device.

### DIP Switch Settings (MultiHop)

Device Settings	Switches							
	1	2	3	4	5	6	7	8
Serial line baud rate 19200 OR User defined receiver slots	OFF*	OFF*						
Serial line baud rate 38400 OR 32 receiver slots	OFF	ON						
Serial line baud rate 9600 OR 128 receiver slots	ON	OFF						
Serial line baud rate Custom OR 4 receiver slots	ON	ON						
Parity: None			OFF*	OFF*				
Parity: Even			OFF	ON				

Device Settings	Switches							
	1	2	3	4	5	6	7	8
Parity: Odd			ON	OFF				
Disable serial (low power mode) and enable the receiver slots select for switches 1-2			ON	ON				
Transmit power 900 MHz radios: 1.00 Watt (30 dBm) 2.4 GHz radios: 0.065 Watts (18 dBm) and 60 ms frame					OFF*			
Transmit power 900 MHz radios: 0.25 Watts (24 dBm) 2.4 GHz radios: 0.065 Watts (18 dBm) and 40 ms frame					ON			
Application mode: Modbus						OFF*		
Application mode: Transparent						ON		
MultiHop radio setting: Repeater							OFF*	OFF*
MultiHop radio setting: Master							OFF	ON
MultiHop radio setting: Slave							ON	OFF
MultiHop radio setting: Reserved							ON	ON

\* Default configuration

### Application Mode

The MultiHop radio operates in either Modbus mode or transparent mode. Use the internal DIP switches to select the mode of operation. All MultiHop radios within a wireless network must be in the same mode.

Modbus mode uses the Modbus protocol for routing packets. In Modbus mode, a routing table is stored in each parent device to optimize the radio traffic. This allows for point to point communication in a multiple data radio network and acknowledgement/retry of radio packets. To access a radio's I/O, the radios must be running in Modbus mode.

In transparent application mode, all incoming packets are stored, then broadcast to all connected data radios. The data communication is packet based and not specific to any protocol. The application layer is responsible for data integrity. For one to one data radios it is possible to enable broadcast acknowledgement of the data packets to provide better throughput. In transparent mode, there is no access to the radio's I/O.

### Baud Rate and Parity

The baud rate (bits per second) is the data transmission rate between the device and whatever it is physically wired to. Set the parity to match the parity of the device you are wired to.

### Disable Serial

If the local serial connection is not needed, disable it to reduce the power consumption of a data radio powered from the solar assembly or from batteries. All radio communications remain operational.

### Receiver Slots

The number of receiver slots indicates the number of times out of 128 slots/frames the radio can transmit to its parent radio. Setting a slave's receiver slots to 4 reduces the total power consumption by establishing that the slave can only transmit to its parent four times per 128 slots.

### Transmit Power Levels/Frame Size

The 900 MHz data radios can be operated at 1 watt (30 dBm) or 0.250 watt (24 dBm). For most models, the default transmit power is 1 watt.

For 2.4 GHz radios, the transmit power is fixed at 0.065 watt (18 dBm) and DIP switch 5 is used to set the frame timing. The default position (OFF) sets the frame timing to 60 milliseconds. To increase throughput, set the frame timing to 40 milliseconds. Note that increasing the throughput decreases the battery life.

*Prior to date code 15341 and radio firmware version 3.6, the frame timing was 40 ms (OFF) or 20 ms (ON).*

## Wiring Diagrams

	Pin	Description	Diagram Label
	1	Analog IN 1 (0 to 20 mA)	AI1
	2	Analog IN 2 (0 to 20 mA)	AI2
	3	Discrete IN 3 (PNP)	DI3
	4	Discrete IN 4 (PNP)	DI4
	5	Ground	GND
	6	Discrete OUT 1 (PNP)	DO1
	7	Discrete OUT 2 (PNP)	DO2
	8	Analog OUT 1 (0 to 20 mA)	AO1
	9	Analog OUT 2 (0 to 20 mA)	AO2
	10	RS-485 + Host communication connection	
	11	RS-485 – Host communication connection	
	12	Ground	GND
	13	10 to 30 V dc	PWR
	14	Ground	GND

Discrete Input Wiring for PNP Sensors

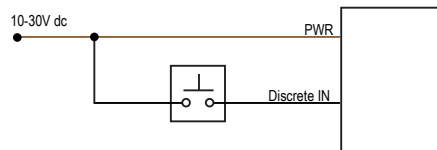

Discrete Output Wiring (PNP)

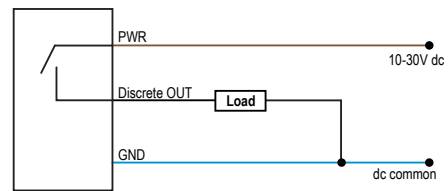

Analog Input Wiring (10–30 V dc Power)

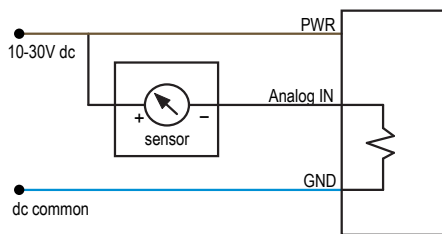

Analog Output Wiring

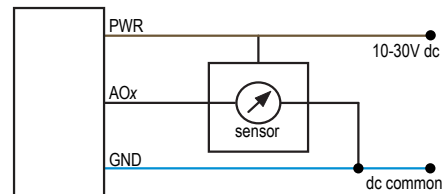

## Set the MultiHop Radio (Slave) ID

On a MultiHop radio, use the rotary dials to set the device's MultiHop Radio ID.

Modbus Slave IDs 01 through 10 are reserved for slaves directly connected to the host (local I/O). Polling messages addressed to these devices are not relayed over the wireless link. Use Modbus Slave IDs 11 through 60 for MultiHop master, repeater, and slave radios. Up to 50 devices (local slaves and remote slaves) may be used in this system.

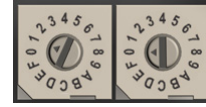

With the left dial acting as the left digit and the right dial acting as the right digit, the MultiHop Radio ID can be set from 01 through 60.

## Bind the MultiHop Radios to Form Networks

To create your MultiHop network, bind the repeater and slave radios to the designated master radio.

1. Apply power to all MultiHop radios and place the MultiHop radios configured as slaves or repeaters at least two meters away from the master radio.
2. Put the MultiHop master radio into binding mode.
  - For two button master radios, triple-click button 2.
  - For one button master radios, triple-click the button.

For the two LED/button models, both LEDs flash red and the LCD shows \*BINDNG and \*MASTER. For single LED/button models, the LED flashes alternatively red and green.

3. Put the MultiHop repeater or slave radio into binding mode.
  - For two button radios, triple-click button 2.
  - For one button radios, triple-click the button.

The child radio enters binding mode and searches for any Master radio in binding mode. While searching for the Master radio, the two red LEDs flash alternately. When the child radio finds the Master radio and is bound, both red LEDs are solid for four seconds, then both red LEDs flash simultaneously four times. For M-GAGE Nodes, both colors of the single LED are solid (looks orange), then flash. After the slave/repeater receives the binding code transmitted by the master, the slave and repeater radios automatically exit binding mode.

4. Repeat step 3 for as many slave or repeater radios as are needed for your network.
5. When all MultiHop radios are bound, exit binding mode on the master.
  - For two button master radios, double-click button 2.
  - For one button master radios, double-click the button.

All radio devices begin to form the network after the master data radio exits binding mode.

### Child Radios Synchronize to the Parent Radios

The synchronization process enables a SureCross radio to join a wireless network formed by a master radio. After power-up, synchronization may take a few minutes to complete. First, all radios within range of the master data radio wirelessly synchronize to the master radio. These radios may be slave radios or repeater radios.

After repeater radios are synchronized to the master radio, any radios that are not in sync with the master but can "hear" the repeater radio will synchronize to the repeater radios. Each repeater "family" that forms a wireless network path creates another layer of synchronization process. The table below details the process of synchronization with a parent. When testing the devices before installation, verify the radio devices are at least two meters apart or the communications may fail.

### Slave and Repeater LED Behavior

All bound radios set to slave or repeater modes follow this LED behavior after powering up.

		Two Button/LED Models		Single Button/LED Models
Process Steps	Response	LED 1	LED 2	LED
1	Apply power to the radio	-	Solid amber (briefly)	Amber
2	The slave/repeater searches for a parent device.	Flashes red	-	Flashes red (1 per 3 sec)
3	A parent device is detected. The slave/repeater searches for other parent radios within range.	Solid red	-	Solid red

Process Steps	Response	Two Button/LED Models		Single Button/LED Models
		LED 1	LED 2	LED
4	The slave/repeater selects a suitable parent.	-	Solid amber	Solid amber
5	The slave/repeater attempts to synchronize to the selected parent.	-	Solid red	Solid red
6	The slave/repeater is synchronized to the parent.	Flashes green	-	Flashes green
7	The slave/repeater enters RUN mode.	Solid green, then flashes green	-	Solid green, then flashes green
	Serial data packets begin transmitting between the slave/repeater and its parent radio.	-	Flashes amber	Flashes amber

## Master LED Behavior

All bound radios set to operate as masters follow this LED behavior after powering up.

Process Steps	Response	Two Button/LED Models		Single Button/LED Models
		LED 1	LED 2	LED
1	Apply power to the master radio	-	Solid amber	Solid amber
2	The master radio enters RUN mode.	Flashes green	-	Flashes green
	Serial data packets begin transmitting between the master and its children radios.	-	Flashes amber	Flashes amber

## Modbus Register Table

Register (4xxxx)	Input #	Input Type	Units	I/O Range		Holding Register Representation		Pins
				Min.	Max.	Min. (Dec.)	Max. (Dec.)	
1	1							
2	2							
3	3	Discrete IN 3	-	0	1	0	1	Pin 3
4	4	Discrete IN 4	-	0	1	0	1	Pin 4
5	5	Analog IN 1	mA	0.0	20.0	0	65535	Pin 1
6	6	Analog IN 2	mA	0.0	20.0	0	65535	Pin 2

Register (4xxxx)	Output #	Output Type	Units	I/O Range		Holding Register Representation		Pins
				Min.	Max.	Min. (Dec.)	Max. (Dec.)	
501	1	Discrete OUT 1	-	0	1	0	1	Pin 6
502	2	Discrete OUT 2	-	0	1	0	1	Pin 7
503	3	Analog OUT 1	mA	0.0	20.0	0	65535	Pin 8
504	4	Analog OUT 2	mA	0.0	20.0	0	65535	Pin 9

## Modbus Addressing Convention

All Modbus addresses refer to Modbus holding registers. When writing your own Modbus scripts, use the appropriate commands for interfacing to holding registers. Parameter description headings refer to addresses in the range of 40000 as is customary with Modbus convention.

## Modbus Register Configuration

Change the factory default settings for the inputs, outputs, and device operations using the device Modbus registers. To change parameters, set the data radio network to Modbus mode and assign the data radio a valid Modbus slave ID.

Generic input or output parameters are grouped together based on the device input or output number: input 1, input 2, output 1 etc. Operation type specific parameters (discrete, counter, analog 4 to 20 mA) are grouped together based on the I/O type number: analog 1, analog 2, counter 1, etc. Not all inputs or outputs may be available for all models. To determine which specific I/O is available on your model, refer to the Modbus Input/Output Register Maps listed in the device's datasheet. For more information about registers, refer to the [MultiHop Product Manual](#) (p/n 151317).

## Factory Default Configuration

### Discrete Inputs (PNP)

Enable	Sample	Boost Enable	Boost Warmup	Boost Voltage	Extended Input Read	NPN/PNP	Sample High	Sample Low
ON	40 ms	OFF	OFF	OFF	OFF	PNP	OFF	OFF

### Analog Inputs

Enable	Sample	Boost Enable	Boost Warmup	Boost Voltage	Extended Input Read	Analog Max	Analog Min	Enable Fullscale
ON	1 sec	OFF	OFF	OFF	OFF	20000	0	ON

### Discrete Outputs

Enable	Flash Enable
ON	OFF

### Analog Outputs

Enable	Analog Max	Analog Min	Enable Fullscale	Hold Last State Enable	Default Output State
ON	20000	0	ON	OFF	0

## Specifications

### Radio Range

900 MHz, 1 Watt: Up to 9.6 km (6 miles)  
2.4 GHz, 65 mW: Up to 3.2 km (2 miles)

### Minimum Separation Distance

900 MHz, 1 Watt: 4.57 m (15 ft)  
2.4 GHz, 65 mW: 0.3 m (1 ft)

### Radio Transmit Power

900 MHz, 1 Watt: 30 dBm (1 W) conducted (up to 36 dBm EIRP)  
2.4 GHz, 65 mW: 18 dBm (65 mW) conducted, less than or equal to 20 dBm (100 mW) EIRP

### Supply Voltage

10 to 30 V dc (Outside the USA: 12 to 24 V dc,  $\pm 10\%$ ). <sup>1</sup>  
Typical average consumption: 25 mA  
Maximum consumption: Less than 100 mA at 24 V dc

### Interface

One red/green LED  
One push button

### Antenna Connection

Ext. Reverse Polarity SMA, 50 Ohms: Max Tightening Torque: 0.45 N·m (4 lbf·in)  
U.FL-R-SMT.(01): Use cable BWA-HW-030 (U.FL to RP-SMA) or the equivalent

<sup>1</sup> For European applications, power the DX80 from a Limited Power Source as defined in EN 60950-1.

**900 MHz Compliance (1 Watt)**

FCC ID UE3RM1809: This device complies with FCC Part 15, Subpart C, 15.247  
 IC: 7044A-RM1809

**2.4 GHz Compliance (MultiHop)**

FCC ID UE300DX80-2400 - This device complies with FCC Part 15, Subpart C, 15.247  
 ETSI EN 300 328: V1.8.1 (2012-04)  
 IC: 7044A-DX8024

**Communication Hardware (MultiHop Board Models, RS-485)**

Interface: 2-wire half-duplex RS-485  
 Baud rates: 9.6k, 19.2k (default), or 38.4k via DIP switches; 1200, 2400, 57.6k, and 115.2k via the MultiHop Configuration Tool  
 Data format: 8 data bits, no parity, 1 stop bit

**Packet Size (MultiHop)**

900 MHz: 175 bytes (85 Modbus registers)  
 2.4 GHz: 75 bytes (37 Modbus registers)

**Intercharacter Timing (MultiHop)**

3.5 milliseconds

**Discrete Inputs**

Rating: 3 mA max current at 30 V dc  
 Sample Rate: 40 milliseconds  
 ON Condition: Greater than 8 V  
 OFF Condition: Less than 5 V

**Analog Inputs**

Rating: 24 mA  
 Impedance: Approx. 100 Ohms <sup>2</sup>  
 Sample Rate: 1 second  
 Accuracy: 0.1% of full scale +0.01% per °C  
 Resolution: 12-bit

**Discrete Output Rating (PNP)**

100 mA max current at 30 V dc  
 ON-State Saturation: Less than 3 V at 100 mA  
 OFF-state Leakage: Less than 10 µA

**Discrete Output ON Condition**

Supply minus 2 V

**Discrete Output OFF Condition**

Less than 2 V

**Analog Outputs**

Rating: 24 mA  
 Update Rate: 125 milliseconds  
 Accuracy: 0.1% of full scale +0.01% per °C  
 Resolution: 12-bit

**Operating Environment**

-40 °C to +85 °C (-40 °F to +185 °F)<sup>3</sup>  
 95% maximum relative humidity (non-condensing)  
 Radiated Immunity: 10 V/m (EN 61000-4-3)

**Certifications**



**MultiHop M-HBx and Performance PBx Models Mounted on the Base**

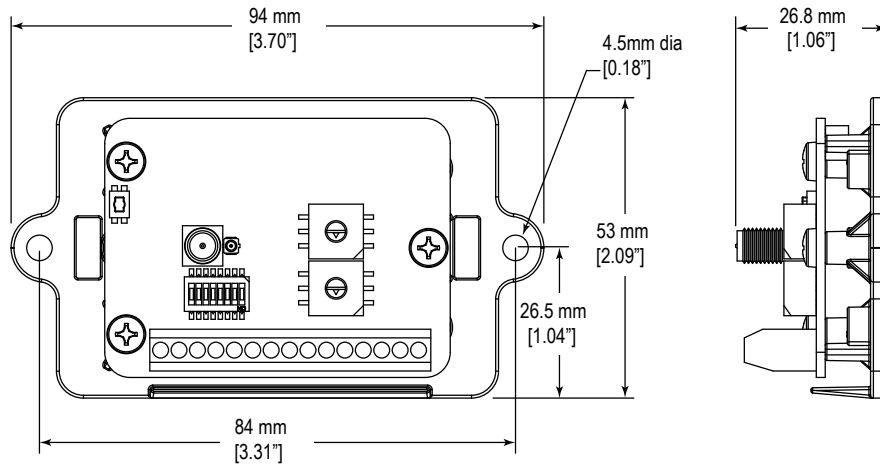

Figure 1. Most MultiHop M-HBx and Performance PBx models ship from the factory mounted on a plastic base.

**Accessories for the Board Models**

<p><b>BWA-HW-034</b></p> <ul style="list-style-type: none"> <li>DIN rail clip, black plastic</li> </ul> 	<p><b>BWA-HW-030</b></p> <ul style="list-style-type: none"> <li>u.FL to RP-SMA adapter cable</li> </ul> 
---	---

<sup>2</sup> To verify the analog input's impedance, use an Ohm meter to measure the resistance between the analog input terminal (AIx) and the ground (GND) terminal.  
<sup>3</sup> Operating the devices at the maximum operating conditions for extended periods can shorten the life of the device.



## Warnings

---

**Antenna Installations.** Install and properly ground a qualified surge suppressor when installing a remote antenna system. Remote antenna configurations installed without surge suppressors invalidate the manufacturer's warranty. Keep the ground wire as short as possible and make all ground connections to a single-point ground system to ensure no ground loops are created. No surge suppressor can absorb all lightning strikes; do not touch the Sure Cross® device or any equipment connected to the Sure Cross device during a thunderstorm.

**Exporting Sure Cross® Radios.** It is our intent to fully comply with all national and regional regulations regarding radio frequency emissions. Customers who want to re-export this product to a country other than that to which it was sold must ensure the device is approved in the destination country. A list of approved countries appears in the *Radio Certifications* section of the product manual. The Sure Cross wireless products were certified for use in these countries using the antenna that ships with the product. When using other antennas, verify you are not exceeding the transmit power levels allowed by local governing agencies. Consult with Banner Engineering Corp. if the destination country is not on this list.

**Violating Warnings.** The manufacturer does not take responsibility for the violation of any warning listed in this document. Make no modifications to this product; any modifications to this product not expressly approved by Banner Engineering could void the user's authority to operate the product. All specifications published in this document are subject to change; Banner reserves the right to modify product specifications or update documentation at any time. For the most recent version of any documentation, refer to: [www.bannerengineering.com](http://www.bannerengineering.com). © Banner Engineering Corp. All rights reserved.

## Banner Engineering Corp. Limited Warranty

Banner Engineering Corp. warrants its products to be free from defects in material and workmanship for one year following the date of shipment. Banner Engineering Corp. will repair or replace, free of charge, any product of its manufacture which, at the time it is returned to the factory, is found to have been defective during the warranty period. This warranty does not cover damage or liability for misuse, abuse, or the improper application or installation of the Banner product.

THIS LIMITED WARRANTY IS EXCLUSIVE AND IN LIEU OF ALL OTHER WARRANTIES WHETHER EXPRESS OR IMPLIED (INCLUDING, WITHOUT LIMITATION, ANY WARRANTY OF MERCHANTABILITY OR FITNESS FOR A PARTICULAR PURPOSE), AND WHETHER ARISING UNDER COURSE OF PERFORMANCE, COURSE OF DEALING OR TRADE USAGE.

This Warranty is exclusive and limited to repair or, at the discretion of Banner Engineering Corp., replacement. IN NO EVENT SHALL BANNER ENGINEERING CORP. BE LIABLE TO BUYER OR ANY OTHER PERSON OR ENTITY FOR ANY EXTRA COSTS, EXPENSES, LOSSES, LOSS OF PROFITS, OR ANY INCIDENTAL, CONSEQUENTIAL OR SPECIAL DAMAGES RESULTING FROM ANY PRODUCT DEFECT OR FROM THE USE OR INABILITY TO USE THE PRODUCT, WHETHER ARISING IN CONTRACT OR WARRANTY, STATUTE, TORT, STRICT LIABILITY, NEGLIGENCE, OR OTHERWISE.

Banner Engineering Corp. reserves the right to change, modify or improve the design of the product without assuming any obligations or liabilities relating to any product previously manufactured by Banner Engineering Corp.